

Alpha

User Guide

Spectrophotometer from K LAB CO.,LTD.

Alpha

User Guide

This page is intentionally left blank.

Introduction

Thank you for purchasing Alpha, the UV-Vis spectrophotometer from K LAB.

This User Guide describes the details of installation, operation, cautions for users, accessories, and options of Alpha. Please read the User Guide before using the product and follow the instructions when using the product. Moreover, keep the User Guide properly for your reference.

Important

Keep this User Guide with the product.

Familiarize with safety guidance before using the product to ensure that you operate the product safely and properly. Contact K LAB Customer Center if you need to recalibrate or reinstall the product. Contact K LAB Customer Center if the User Guide is lost or damaged.



Copyright

- Any material in this User Guide may not be altered or distributed in any form without prior consent from K LAB.

© 2025 K LAB Corporation. All rights reserved.

Safety

- Thoroughly familiarize with safety guidance before using the product to ensure that you operate the product safely. Follow all warnings and cautions in the User Guide.
- Damage to the product or injury to the user may occur when using the product outside its intended use.
- Unauthorized repairs or structural changes may cause performance and quality problems.
- K LAB shall not be liable for any damages arising from improper use or any violation of laws, rules, regulations related to safety.
- The warning and cautions are presented using the following rules in this manual:

 Warning	This mark indicates a potentially risky situation, and failure to follow the instruction may lead to serious injury or even death.
 Caution	This mark indicates a potentially risky situation, and failure to follow the instruction may lead to a light injury or product damage.
 Note	This mark indicates additional information provided to ensure proper use of this product.

- To prevent damage to the product, and injury or death to the user, please read the information with the above symbols.

Caution

Caution for Installed Area

Warning

Install a ventilation system in the installed area if you use a flammable or toxic sample.

Caution

· The size and weight of this product are as follows.

Overall Size (W x D x H)	520 mm x 510 mm x 200 mm
Weight	14 kg

- Consider the total weight during the product installation. The table on which the product is installed must be able to withstand the total weight of the product.
- Use a stable table with the depth of at least 520 mm. Otherwise, the product may tilt or fall.
- Avoid areas that are exposed to corrosive vapor or excessive dust. Such adverse conditions can be detrimental to the performance of the product and can shorten its life.
- The range of environmental conditions when installing the product is as follows:

Temperature Range	5~40 °C
Moisture Range	30~80%
Altitude	Up to 3,100 m
Pollution Degree	2
Used Place	Indoor use only

- Please check the environment of the installation site to meet the following requirements.
 - Where there is no dust, corrosive gas or vibration
 - Where RSRP(Reference Signal Received Power) does not exceed -70dBm
 - Where it is not exposed to direct sunlight or an environment of high temperature and humidity

Caution

Caution for Installed Area

Warning

- Please confirm the input rating information of the equipment (power supply voltage, power consumption and frequency) and apply power to the equipment.

Voltage	95~240 VAC
Frequency	50/60 Hz
Power Consumption	140 W

- Grounding is crucial to prevent electric shock and ensure reliable operation due to sudden accidents or power interruption. Connecting to a power source without protective earth connection may cause electric shock or damage to the product.
- Do not place a heavy object on the power cord. Keep hot objects away from the product.
- Do not modify the power cord by any means.
- In case of an earthquake or disaster, take precautions to prevent the equipment from falling.

Caution

- The fan is built into the back of the product. Please keep a certain distance when installing on the wall.

Caution

Operating Precautions

Warning

- Using the product in a manner not specified in this manual may damage the product.
- If an emergency occurs, remove the power plug.
- Always turn off the lamp before opening the lamp cover, as this may damage the eyesight of the user due to the light of the lamp used in the product.
- Visually observing ultraviolet light without any protective equipment can cause visual impairment and permanent blindness.
- There is a risk of burns when you touch the lamp or its surroundings for about 10 minutes after the lamp is turned off.
- If you use the product at a temperature of 50 °C or more, the back of the product may get hot. Please be careful.
- Always wear safety gloves when you are using a specimen that is hazardous or causes biologic infection.

Caution

- Avoid the use of alkaline solution over pH 9.5 as it may damage optical parts.
- Avoid the use of metal corrosive solutions.
- Do not use plastic cells that may be damaged by alcohol or general organic solvents.
- Do not place heavy objects on the product.
- Do not subject the product to external shock or impact.
- When storing the equipment in a place below the reference temperature condition, please use it after storing at room temperature for a certain time because it may cause condensation inside the product.
- Always disconnect the power cable after using the product.
- About 1 hour of preheating is required for commissioning test or measurement. Insufficient warm-up time can cause inaccurate measurements or measurement errors.

Support

Precautions for inspection and maintenance

Warning

- Unplug the power plug during inspection, repair, or maintenance.
- Do not remove the main cover of the product. Doing so may cause injury or product malfunction. This equipment is designed to eliminate the need to remove the main cover during maintenance.
- If the power plug is covered with dust, disconnect the plug from the outlet and remove the dust with a dry cloth.
- If water enters the equipment, wipe it immediately to avoid rust. Do not use alcohol or thinners to clean the equipment.
- You are responsible for handling the sample wastes generated during the analysis. Please dispose of your completed samples in accordance with national laws and regulations for waste disposal.
- The rating and characteristics of the fuse are as follows.

Dimension	20 mm
Voltage Rating	250 V
Current Rating	2 A

Technical support

Warning

- If you have any problems with our product, please contact us or our authorized agent to get service. Please refer to the contact information listed in the back of this guide.
- If a non-certified part is applied to this equipment, the equipment may be damaged.

Product Warranty

K LAB provides the warranty for the product as specified below.

1. Product Warranty Period

Please contact K LAB's Customer Center for the detailed information on the warranty period and scope.

2. Description Product Warranty

K LAB will replace or repair the part at free of charge if the part fails due to an internal defect in the machine (software or hardware) during the warranty period. The consumables or accessories with remaining life may not be subject to free repair or replacement.

3. Exclusion from Product Warranty

The failure caused by any of the following will not be subject to product warranty even during the warranty period.

- 1) Alteration or improper use of the product.
- 2) Product repair or modification of the product by a person or company that is not K LAB or company designated by K LAB.
- 3) Damage to the data including the basic software or product due a virus occurring inside the computer.
- 4) Internal damage of the product caused by electric short or sudden voltage drop.
- 5) Error caused by reasons other than the equipment itself.
- 6) Failure caused by use in a poor environment exposed to strong vibrations or vapor that causes high temperature, humidity, or corrosion.
- 7) Failure caused by external shock including fire, earthquake, or pollution by hazardous material.

* You must comply with the rules specified in the document if the product has documentation such as a warranty or if there is a separate agreement that contains warranty terms. The specific warranty period is provided separately for products that are manufactured differently from the standard specifications for special applications.

Table of Contents

Ch. 1 Introduction

1-1 Structure	16
1-1-1 PC Connection	17
1-2 BIT (Built-In-Test)	18
1-3 Login	19
1-4 Main Page Mode	20
1-4-1 Favorites	21
1-5 Quick Menu and Function	22
1-5-1 Equipment status monitoring function	22
1-5-2 Measured Value Monitoring	22
1-5-3 Lamp Preheating Condition Checking	22
1-5-4 Volume control function	22
1-5-5 Selecting a quick cell type	23
1-5-6 Help	23
1-5-7 Explorer	23

Ch. 2 Photometric Mode (Single Wavelength Mode)

2-1 Description of Photometric Mode	26
2-2 Measurement	27
2-2-1 File Load/Save	28
2-3 Setting	30
2-3-1 Unit Setting	31
2-4 Report	32
2-5 Using Mode (Simple Optical Density Measurement Mode)	33

Ch. 3 Photometric Mode (Multi Wavelength Mode)

3-1 Measurement	38
3-1-1 File Load/Save	39
3-2 Setting	41
3-2-1 Wavelength Input	42
3-2-2 Formula Input	43

3-2-3 Function list	44
3-2-4 Unit Setting	47
3-3 Report	48
3-4 Using Mode	49

Ch. 4 Quantitation Mode

4-1 Description of Quantitation Mode	54
4-1-1 Calibration Curve Manager	54
4-2 File Import/Export	55
4-3 Standard Curve	57
4-3-1 Standard Curve Mode	57
4-3-2 Setting	58
4-3-3 Unit Setting	59
4-3 Quantitation	60
4-4 Report	61
4-5 Using Mode (Standard Curve Generation)	62

Ch. 5 Spectrum Mode

5-1 Mode Main Page	68
5-2 File Load/Save	69
5-3 Setting	71
5-4 Report	72
5-5 Using Mode	73

Ch. 6 Kinetics Mode

6-1 Description of Kinetics Mode	78
6-2 File Load/Save	79
6-3 Setting	81
6-4 Report	82
6-5 Using Mode	83

Ch. 7 Equipment Setting

7-1 General Setting	88
7-2 Sound Setting	89
7-3 Graph Setting	90
7-4 Table Setting	91
7-5 Network Setting	92
7-5-1 Internal Network	92
7-5-2 External Network	93
7-6 Device Setting	94
7-7 Account setting	95
7-8 Printer Setting	96
7-9 Information	97

Ch. 8 Miscellaneous

8-1 Cell Type Settings	100
8-1-1 Single Cell	100
8-1-2 Multi Cell	100
8-2 Explorer	101
8-3 View Change	102
8-3-1 View Change (Graph)	102
8-3-2 View Change (Data)	103

Ch. 9 View Basic Operation

9-1 Connection Settings	
9-1-1 (Option 1) Connection setup using network (1:1 connection)	
9-1-2 (Option 2) Connection setup using network (using a router)	
9-1-3 Connection using a USB=Serial cable	
9-2 View Operation	
9-2-1 Device Connection	
9-2-2 View Operation	

Ch. 1

Introduction

- 1-1 Structure
 - 1-1-1 PC Connection
- 1-2 BIT (Built-In-Test)
- 1-3 Login
- 1-4 Main Page Mode
 - 1-4-1 Favorites
- 1-5 Quick Menu and Function
 - 1-5-1 Equipment status monitoring function
 - 1-5-2 Measured Value Monitoring
 - 1-5-3 Lamp Preheating Condition Checking
 - 1-5-4 Volume control function
 - 1-5-5 Selecting a quick cell type
 - 1-5-6 Help
 - 1-5-7 Explorer

1-1 Structure

- ① One-touch type cell holder cover
- ② Multi Cell mounted (standard)
- ③ Lamp replacement cover
- ④ 8.1" Color Screen
- ⑤ 3.0 USB 2 ports (Side)
- ⑥ Detachable front cover (for compatibility)

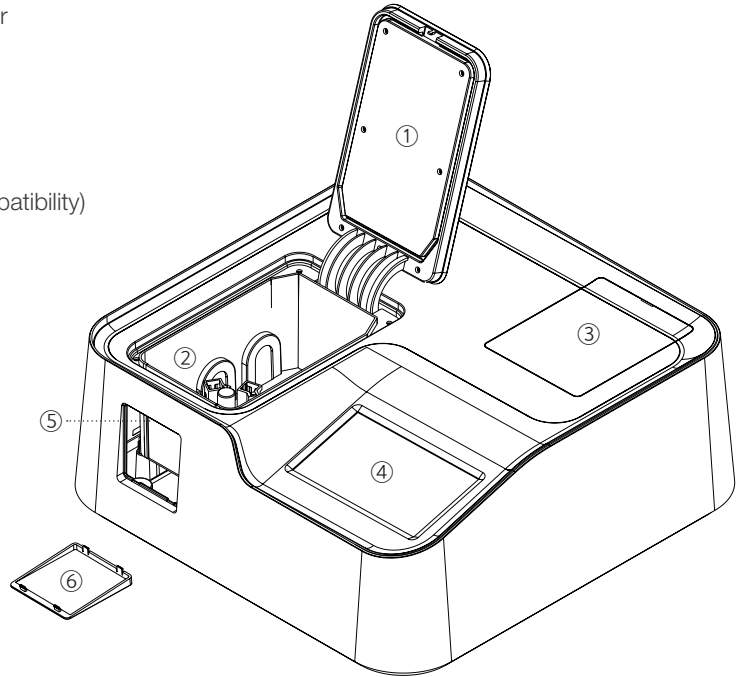

- Ⓐ Air circulator
- Ⓑ Speaker
- Ⓒ Fan
- Ⓓ Main Power
- Ⓔ Ethernet Port
- Ⓕ Accessory port
- Ⓖ 3.0 USB (2 Ports)
- Ⓗ PC connection port

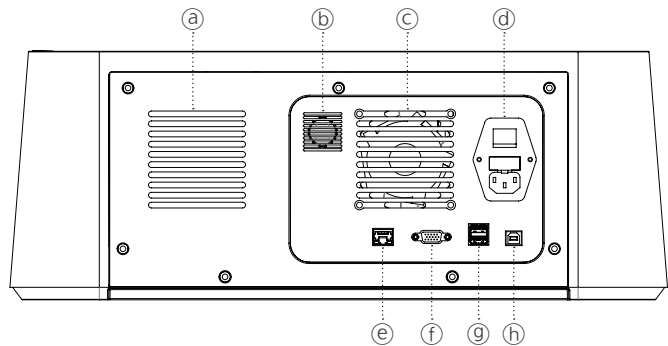

i Note

- AC Power Connector: AC power socket for AC power cable connection
- Ethernet Port: Port used to control equipment using PC program
- Serial Port: RS232 communication port required to attach additional accessories to the equipment

1-1-1 PC Connection

- ① Connect the AC power connector to the power outlet using the AC power cable for power supply.
- ② To communicate with PC, connect PC and router, device and router using LAN cable, respectively.
However, when connecting to router, WAN port is not used.

i Note

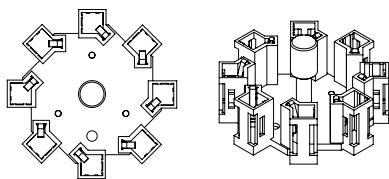

The Multi Cell is adopted as a standard

You can measure more specimens automatically using the Multi Cell holder mounted as a standard.

1-2 BIT(Built-In-Test, BIT)

Ch.1

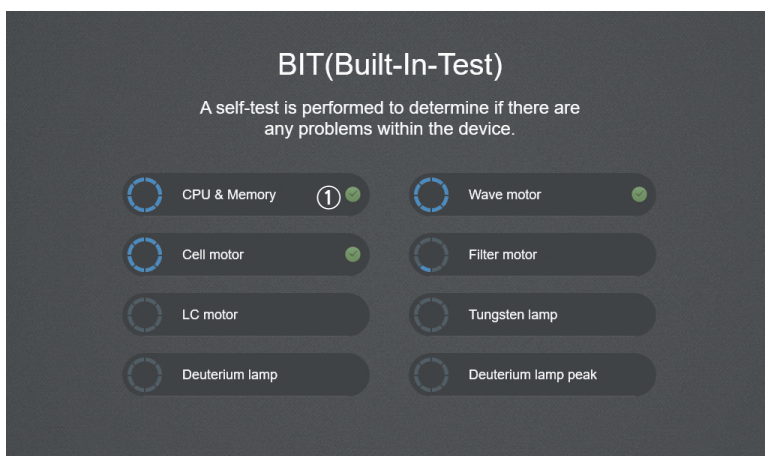

Fig. 1.1

When power is supplied to the equipment, self-diagnosis is performed to check whether the equipment is running properly. The self-diagnosis list is as follows.

- CPU & Memory
- Wave motor
- Cell motor
- Filter motor
- LC motor
- Tungsten lamp
- Deuterium lamp

Each item is checked and the result is indicated as follows. If the equipment runs normally, it will be indicated on the screen as ① ✓, Otherwise, it will be indicated as ① !. If all equipment states are normal, the main screen will be displayed automatically. If a warning appears, such as ① !, please refer to the homepage or contact the technical support or A/S center.

1-3 Login

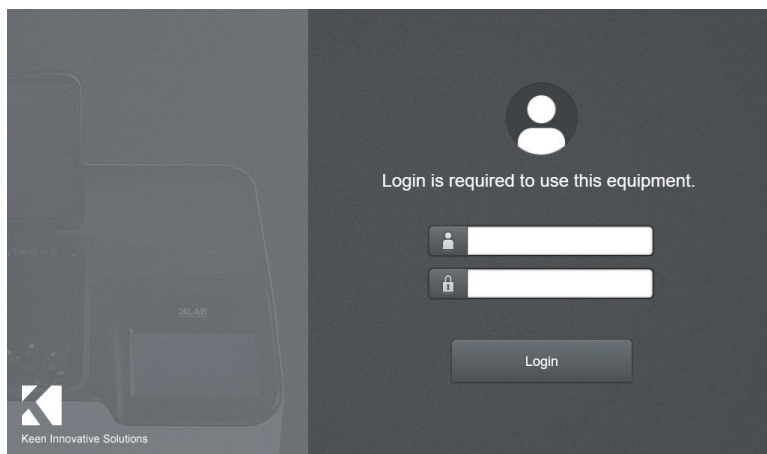

Fig. 1.2

You must enter your user name and password to authenticate when using the equipment. The entered password will be encrypted before sending, and you cannot use the equipment if user authentication fails (if an incorrect user name or password is entered).

i Note

- If you are executing for the first time without registration, select 'Login' first. Or, enter 'admin/ admin' as your ID and password.
- If you need to use the equipment but have forgotten your user name or password, please request technical support via the homepage or contact the customer service center.

1-4 Main Page Mode

Ch.1

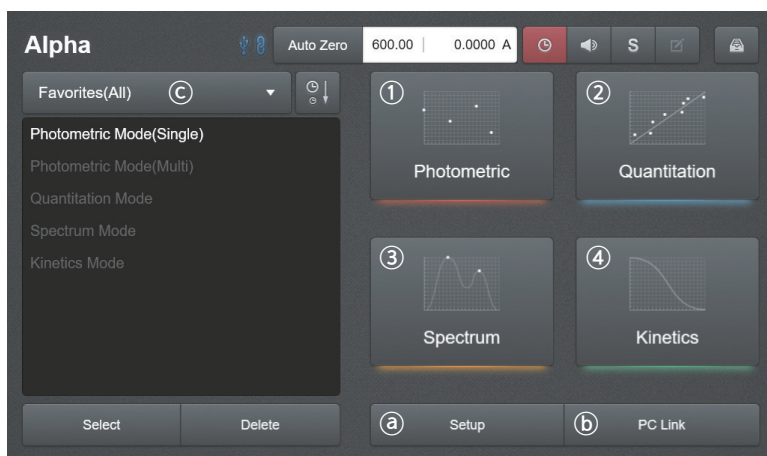

Fig. 1.3

① Photometric Mode (Absorbance Measurement Mode)

- This mode enables easy measurement of absorbance (Abs) (or transmittance (%T)) in a specific wavelength.
- You can set up to 8 wavelengths, and the absorbance for each wavelength is automatically measured.
- You can use the MultiCell holder to analyze up to 8 specimens automatically.

② Quantitation Mode (Fixed Amount Analysis Mode)

- The mode uses the MultiCell holder to measure and manage the calibration curve.
- You can analyze a sample quantitatively using the calibration curve generated with up to 8 specimens of various concentrations.
- The product provides four calibration curve types: Linear with Zero Intercept, Linear, Quadratic, Cubic.
- You can generate an accurate calibration curve with up to five repeated measurements.

③ Spectrum Mode (Absorbance Spectrum Acquisition Mode)

- The mode can check the spectrum of the user-specified wavelength band.
- A shortcut key allows the data switch between Abs and %T.
- You can analyze the spectrum of up to 8 specimens automatically.
- The mode includes the functions to magnify the viewing zone and to find the peak and valley positions.

④ Kinetics Mode (Temporal absorption information change confirmation mode)

- This mode enables checking of the absorbance (Abs) (or transmittance (%T)) change with time in a specific wavelength.
- The measurement is made in the specified interval, and the minimum specified interval is 1 second.
- The progress rate is displayed during a measurement of up to 24 hours.
- The mode automatically provides the absorbance change of up to 8 specimens.

ⓐ PC-Link

Change the model of Alpha to Remote mode to interface the product to a PC through View (PC software).

* Please contact K LAB for the PC software.

ⓑ Settings

You can change the default equipment data, network, event, and system setting or calibrate the equipment.

1-4-1, ⓒ Favorites

You can register the data during or after the measurement or analysis and retrieve them quickly for further analysis.

If the ⓒ 즐겨찾기 button is selected, the saved data can be searched by categorizing by mode.

i Note

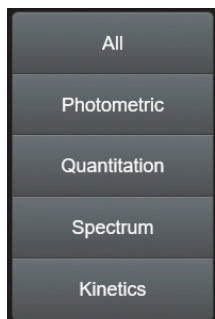

If the ⓒ Favorites button is selected, the button shown in Figure 1.3.1 will appear. If you select the mode button in question, the data corresponding to the selected mode will be aligned from among the saved data.

Fig. 1.3.1

1-5 Quick Menu and Function



Fig. 1.4

1-5-1, ① Equipment status monitoring function

Check the connection status of the equipment and external storage device (USB or mass storage device) in real time.

1-5-2, ② Measured Value Monitoring

You can check the real-time measured value at any time. * The [AUTO ZERO] quick button is provided.

1-5-3, ③ Lamp Preheating Condition Checking

You can check the operating time, lamp preheating condition, and accumulated usage time of lamp to make measurements in optimal condition. * The equipment can begin measurement immediately without preheating.

i Note

▶ Uptime: 00:14:15
▶ W-Lamp: 22h 36m
▶ D2-Lamp: 22h 36m

Operating time: Equipment usage time / Lamp usage time: Total accumulated usage time of lamp.

* The icon of the quick menu is displayed in orange before the lamp preheating.
The icon of the quick menu is displayed in green one hour after the lamp preheating.

1-5-4, ④ Volume control function

Adjust the volume of the equipment to suit the laboratory environment.

1-5-5, ⑤ Selecting a quick cell type

Monitor by changing the cell type without entering the mode, or check the cell status easily as the quick menu cell type icon changes according to the cell type status or location.

* For more details, please refer to Chapter 8-1, "Cell type settings".

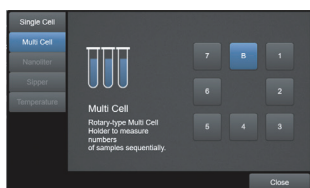
i Note

⑤ The operation moves to the selected cell and begins real-time measurement if you select a cell number in the MultiCell tab.

* You can select only one cell, and the position or condition of the selected cell is displayed in an icon.

Cell condition: M, S / Cell position: M₅, M₁, M₂, M₃, M₄, M₅, M₆ or M₇

1-5-6, ⑥ Help

You can check the description or precautions of program functions or features.

1-5-7, ⑦ Explorer

The files in the equipment storage space and external storage space can be copied or deleted.

* Please refer to **Section 8-2 Explorer in Ch. 8** for more detailed information.

This page is intentionally left blank.

Ch. 2

Photometric Mode (Single Wavelength Mode)

- 2-1 Description of Photometric Mode
- 2-2 Measurement
 - 2-2-1 File Load/Save
- 2-3 Setting
 - 2-3-1 Unit Setting
- 2-4 Report
- 2-5 Using Mode (Simple Optical Density Measurement Mode)

2-1 Description of Photometric Mode

The mode measures the sample specimen in the user-specified wavelength and calculates the absorbance, transmittance, and concentration.

Ch.2

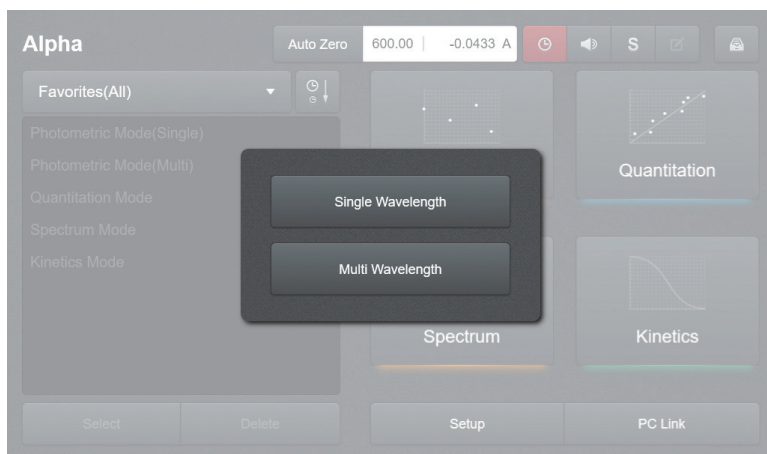

Fig. 2.1

When you select Photometric Mode, the mode selection window to select the single wavelength mode or multi-wavelength mode is created.

* Please refer to **Section 3-1 Measurement in Ch. 3** for more detailed information on multi-wavelength mode.

2-2 Measurement

ABS, %T, and Conc. can be measured.

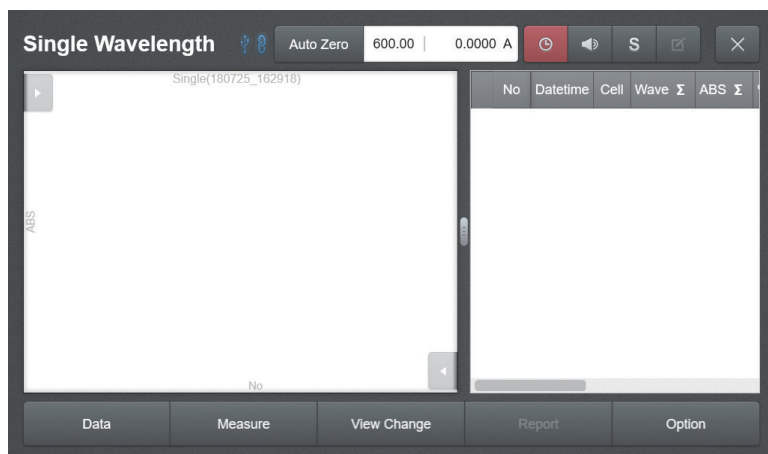

Fig. 2.2

Data (Table) Description

Name	Description
No	Numbers of data.
Datetime	Measured date and time.
Cell	Measured cell no. or measured cell type.
Wave	Measured wavelength.
ABS	Absorbance
%T	Transmission

Description of Main Buttons

Name	Description
Data	Manage measurement data (read; save; delete all).
Measure	Measure absorbance (Abs) or penetration ratio (%T) at a specific wavelength.
View Change	Display the measurement result in a form of graph, data, or graph and data.
Report	View or print the measurement result.
Option	Set default measurement items.

2-2-1 File Load/Save

To Load File

Ch.2

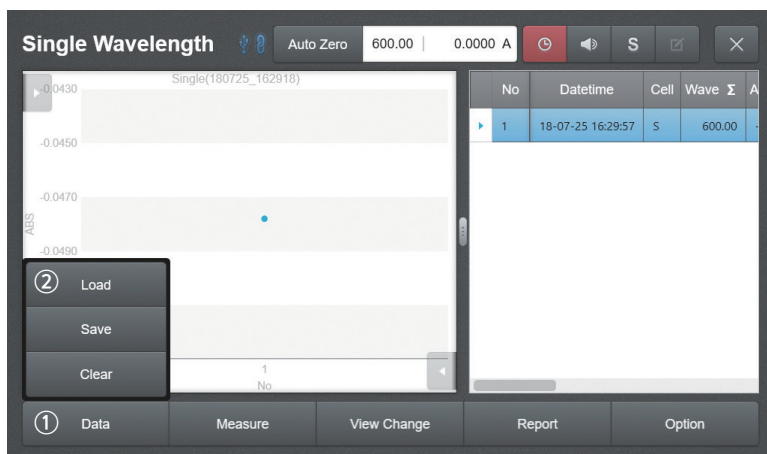

Fig. 2.3

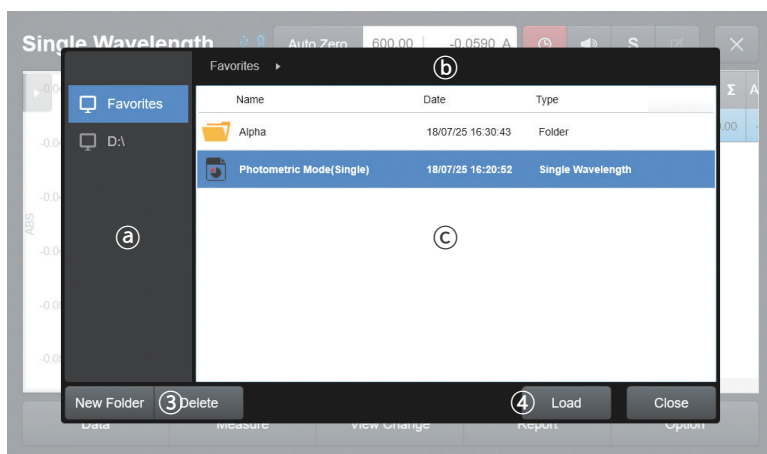

Fig. 2.4 (a) Drive list / (c) Data in pertaining drive / (b) Current folder location

1. Press ② **Load** in the list that appears after selecting ① **Data**
2. Select a drive to read from the (a) list.
3. Select data to read from the (c) list.
4. Select the previous folder name in (b) to return to the previous folder.
5. Press ④ **Load** and read the file.
6. To delete a file, press ③ **Delete**

To Save File

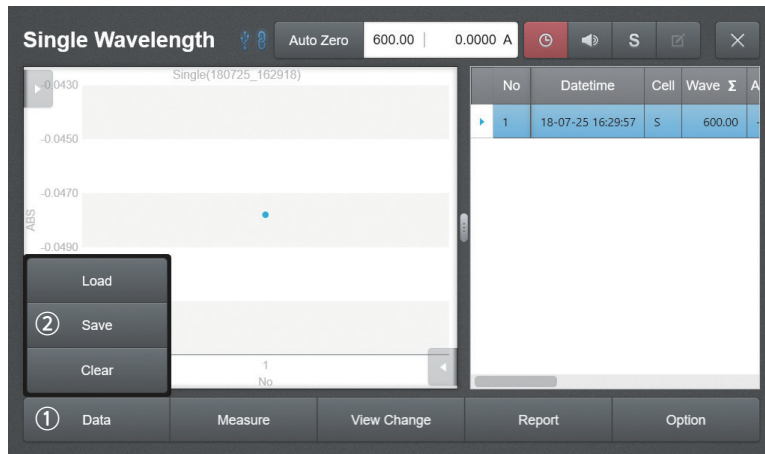

Fig. 2.5

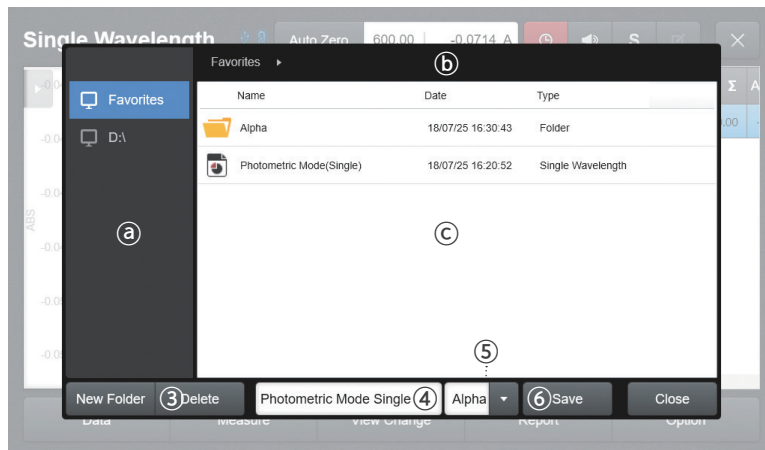

Fig. 2.6 (a) Drive list / (c) Data in pertaining drive / (b) Current folder location

1. Press ② **Save** in the list that appears after selecting ① **Data**
2. Select a drive to save from the (a) list.
3. Enter the name of data to save in ④. * If the file is overwritten, a warning window will be displayed.
4. ⑤ Specify the file format. (Supported file extensions: Alpha, CSV, Excel, TXT)
5. Press ⑥ **Save** to save the file.
6. To delete a file, press ③ **Delete**

2-3 Setting

This section describes the window for measurement settings.

You can specify the Name, Cell Type, Wavelength, Factor, Unit, Memo, and View Change.

Ch.2

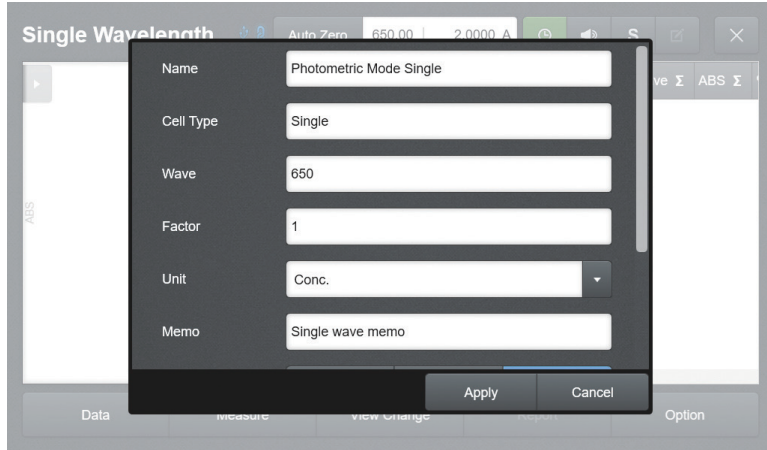

Fig. 2.7

List of Settings

Name	Description	Detailed Description
Name	Specifies the name of the measured data.	
Cell Type	Selects the cell type to be used.	* Refer to 8-1 Cell Type Settings in Ch. 8
Wavelength	Specifies the wavelength to be used.	Operating range: 190 - 1100 nm
Factor	Enters the dilution multiplication or other factors to obtain the concentration value reflecting the factor.	
Unit	Selects the unit to be used.	
Memo	Enters the memo if needed.	
View Change	Display the measurement result in a form of graph, data, or graph and data.	

2-3-1 Unit setting

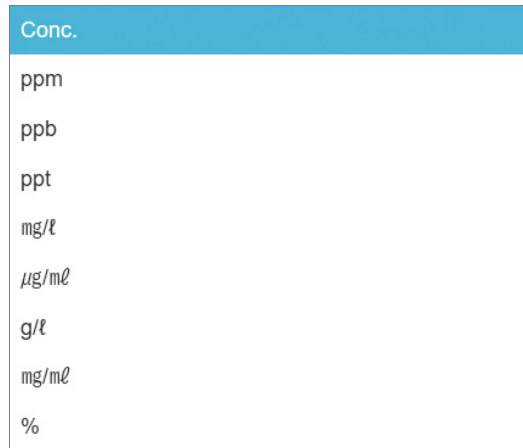

Fig. 2.8

1. [Fig. 2.7] Select the unit item from the list on the settings screen.
2. [Fig. 2.8] Select a unit to use.

2-4 Report

Change the report layout to landscape or portrait and print out the report after preview.

Ch.2

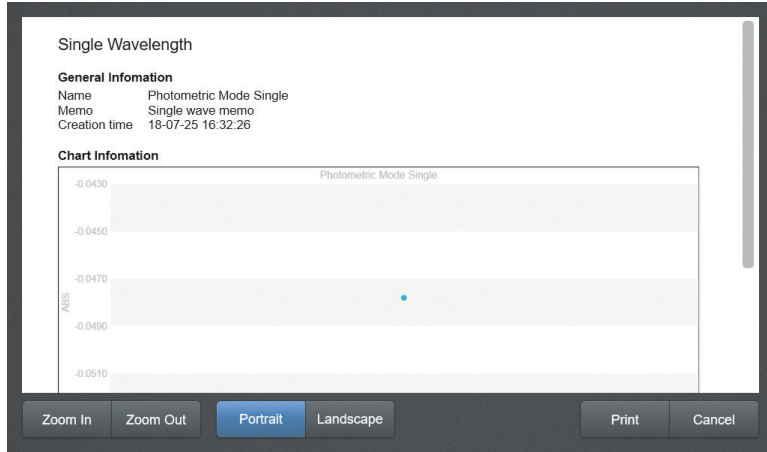

Fig. 2.9

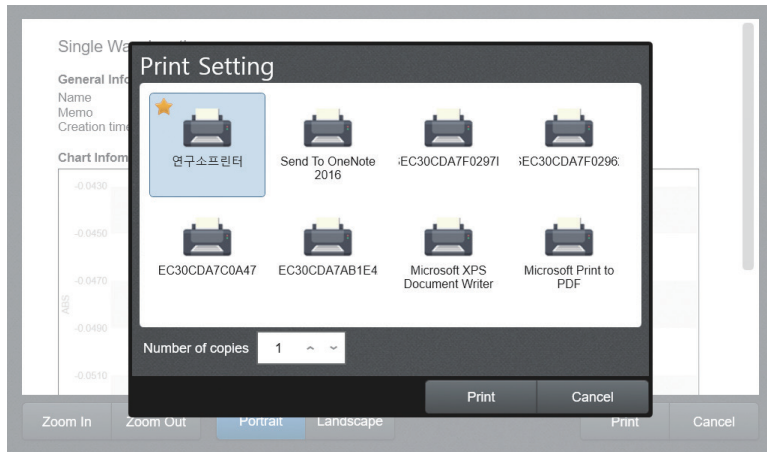

Fig. 2.10

Detailed Description

Name	Description
Zoom In/Out	Zoom in or out on printing details. *Not applied to printing.
Portrait	Changes the printing page to vertical orientation.
Landscape	Changes the printing page to horizontal orientation.
Print	Select a printer. *Refer to Chapter 7, 7-8 "Printer settings" for more information on adding a printer.
Print	Print

2-5 Using Mode (Simple Optical Density Measurement Mode)

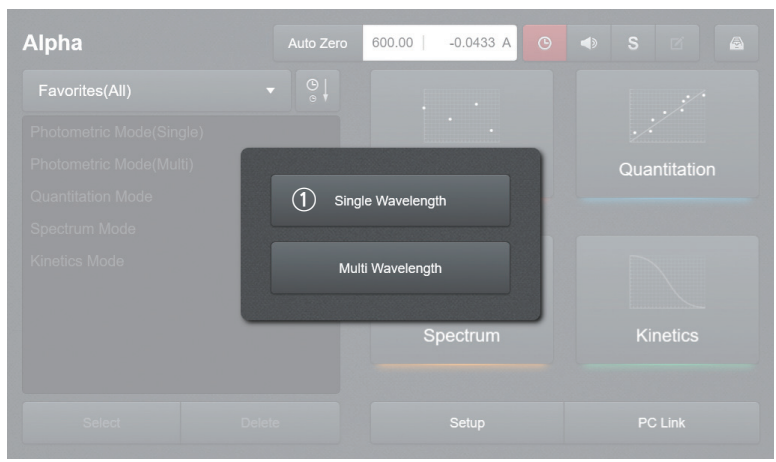

Fig. 2.11

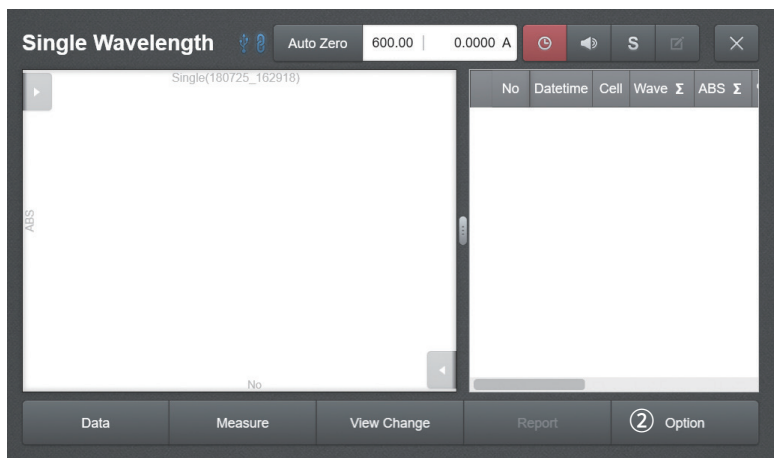

Fig. 2.12

1. [Fig. 2.11] Select ① **Single Wavelength** Mode on the main page.
2. [Fig. 2.12] Move to the ② **Option** and specify the measurement settings.

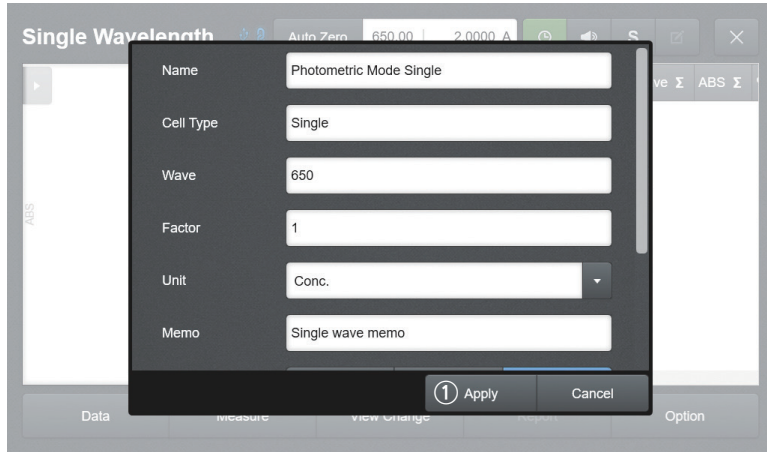

Fig. 2.13

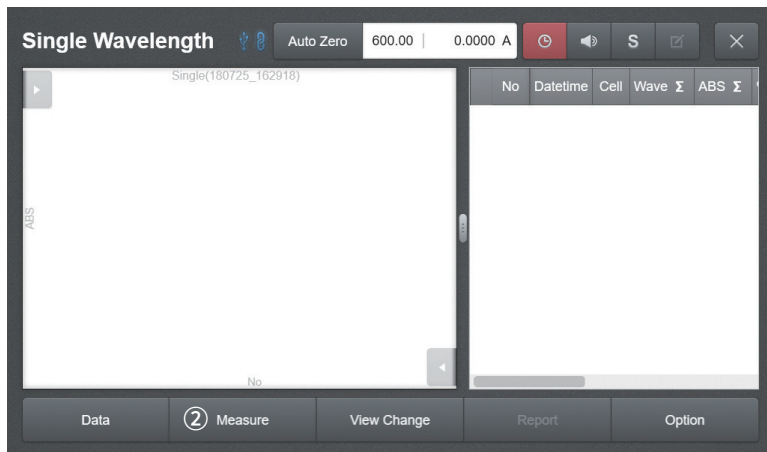

Fig. 2.14

3. [Fig. 2.13] Select and enter the Name, Cell Type, Wavelength, Factor, Unit, Memo, and View Change, then press ① **Apply**
4. [Fig. 2.14] Insert the sample into the pertinent cell holder and press ② **Measure** to take measurements.
5. [Fig. 2.14] If there a sample to add, insert a sample to measure into the pertinent cell holder and press ② **Measure** to take measurements.
6. You can check the measurement data in the table.

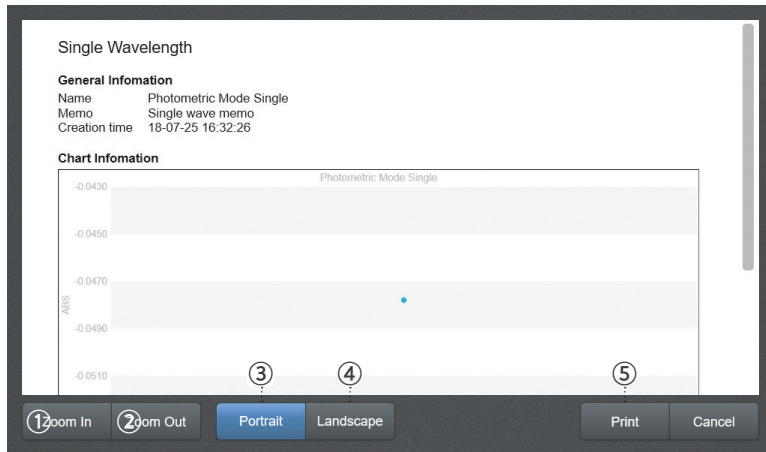

Fig. 2.15

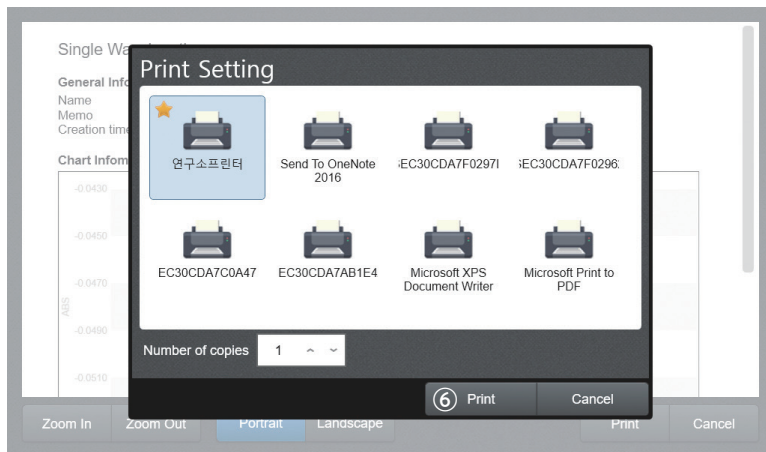

Fig. 2.16

7. Click [Fig. 2.14] **Report** to check or print the measurement data in report form.
8. [Fig. 2.15] You can zoom in or out on the printing details using the ① **Zoom In** or ② **Zoom Out** buttons.
9. [Fig. 2.15] You can check or print in landscape or portrait mode using the ③ **Portrait** and ④ **Landscape** buttons.
10. [Fig. 2.15] Check the details to print and press the ⑤ **Print** button to open the print settings screen.
11. [Fig. 2.16] Set the printer and number of pages to print on the printer settings screen.
12. [Fig. 2.16] Press the ⑥ **Print** button to start printing.

This page is intentionally left blank.

Ch. 3

Photometric Mode (Multi Wavelength Mode)

- 3-1 Measurement
 - 3-1-1 File Load/Save
- 3-2 Setting
 - 3-2-1 Wavelength Input
 - 3-2-2 Formula Input
 - 3-2-3 Function list
 - 3-2-4 Unit Setting
- 3-3 Report
- 3-4 Using Mode

3-1 Measurement

Absorbance measurement regarding multi-wavelength and the resulting value of the expression can be described.

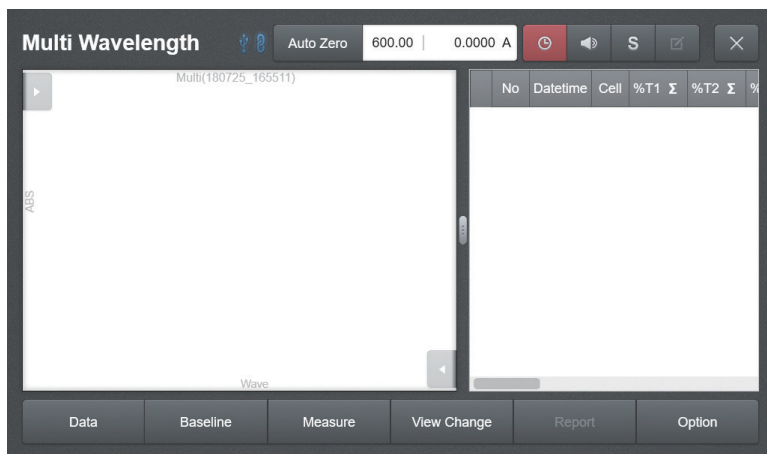

Fig. 3.1

Data (Table) Description

Name	Description	Description
No	Numbers of data.	
Time	Measured date and time.	
Cell	Measured cell no. or measured cell type.	
Wave	Measured wavelength.	
%T(1 ~ 8)	The number of wavelengths that has been set will be displayed.	Up to 8 items can be entered.
ABS(1 ~ 8)	The number of wavelengths that has been set will be displayed.	
Conc.(1 ~ N)	The number of expressions that has been set will be displayed.	

Description of Main Buttons

Name	Description
Data	Manage measurement data (read; save; delete all).
Measure	Measure absorbance (Abs) or penetration ratio (%T) at a specific wavelength.
View Change	Display the measurement result in a form of graph, data, or graph and data.
Report	View or print the measurement result.
Option	Set default measurement items.

3-1-1 File Load/Save

To Load File

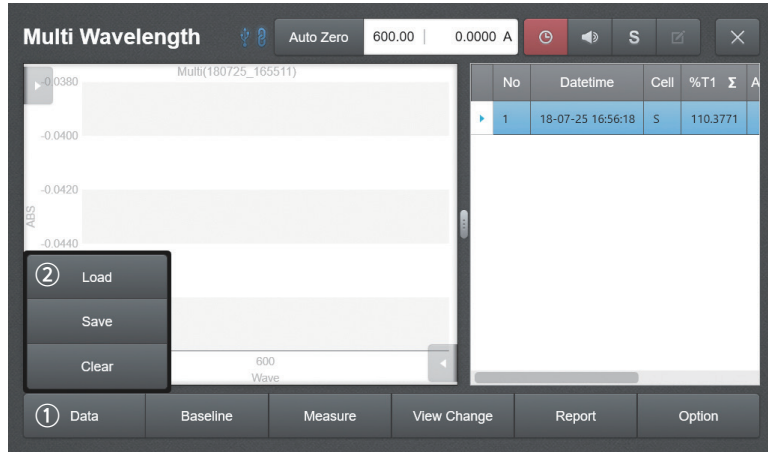

Fig. 3.2

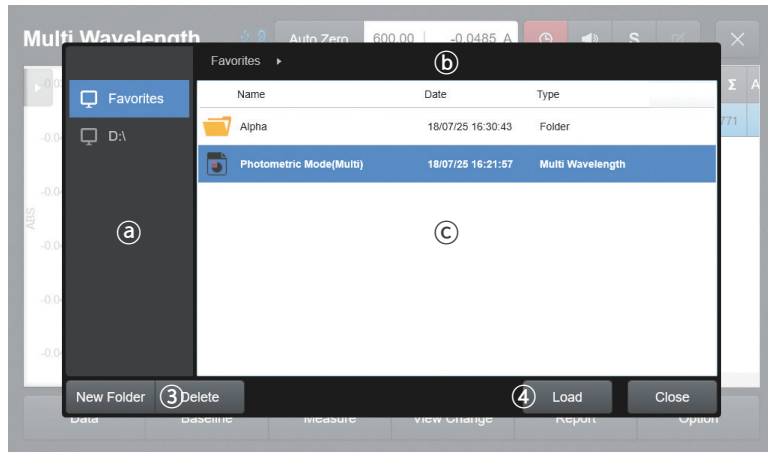

Fig. 3.3 (a) Drive list / (c) Data in pertaining drive / (b) Current folder location

1. Press ② **Load** in the list that appears after selecting ① **Data**
2. Select a drive to read from the (a) list.
3. Select data to read from the (c) list.
4. Select the previous folder name in (b) to return to the previous folder.
5. Press ④ **Load** and read the file.
6. To delete a file, press ③ **Delete**

To Save File

Ch.3

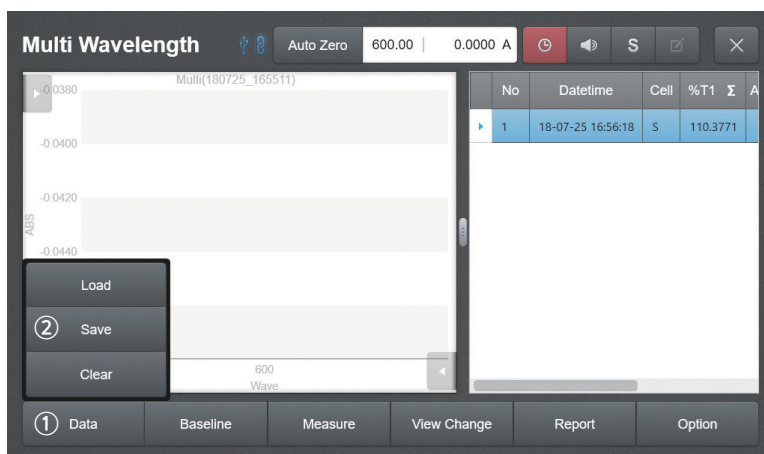

Fig. 3.4

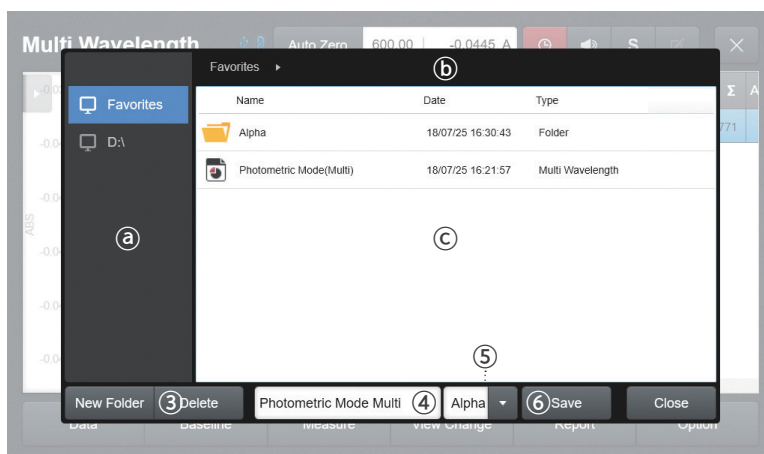

Fig. 3.5 (a) Drive list / (c) Data in pertaining drive / (b) Current folder location

1. Press (2) **Save** in the list that appears after selecting (1) **Data**
2. Select a drive to save from the (a) list.
3. Enter the name of data to save in (4). * If the file is overwritten, a warning window will be displayed.
4. (5) Specify the file format. (Supported file extensions: Alpha, CSV, Excel, TXT)
5. Press (6) **Save** to save the file.
6. To delete a file, press (3) **Delete**

3-2 Setting

You can specify the Name, Cell Type, Wavelength, Factor, Formula, Unit, Memo and View Change.

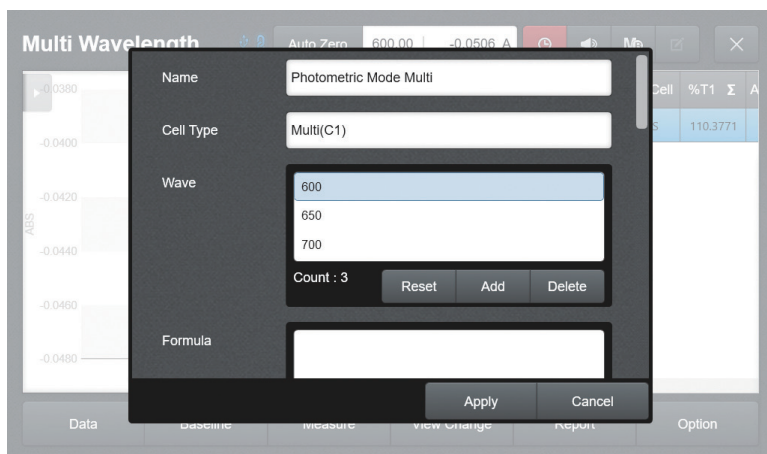

Fig. 3.6

List of Settings

Name	Description	Detailed Description
Name	Specifies the name of the measured data.	
Cell Type	Selects the cell type to be used.	* Refer to 8-1 Cell Type Settings in Ch. 8
Wavelength	Specifies the wavelength to be used.	Operating range: 190 - 1100 nm
Factor	Enters the dilution multiplication or other factors to obtain the concentration value reflecting the factor.	
Formula	Add a formula using variables and function(s).	
Unit	Selects the unit to be used.	
Memo	Enters the memo if needed.	
View Change	Display the measurement result in a form of graph, data, or graph and data.	

3-2-1 Wavelength Input

Ch.3

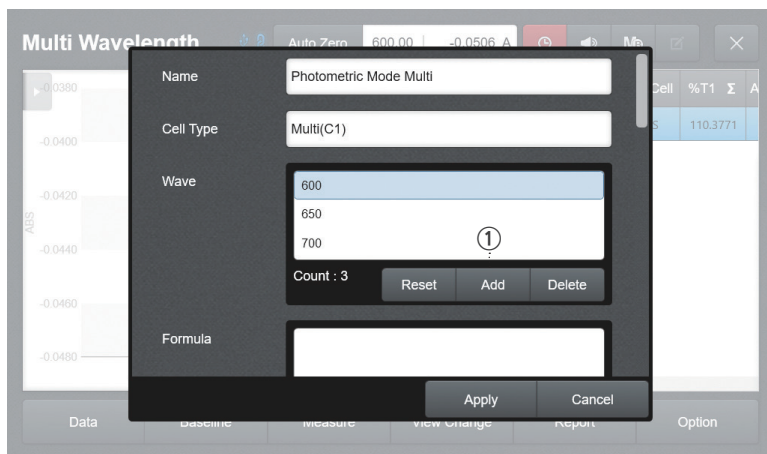

Fig. 3.7

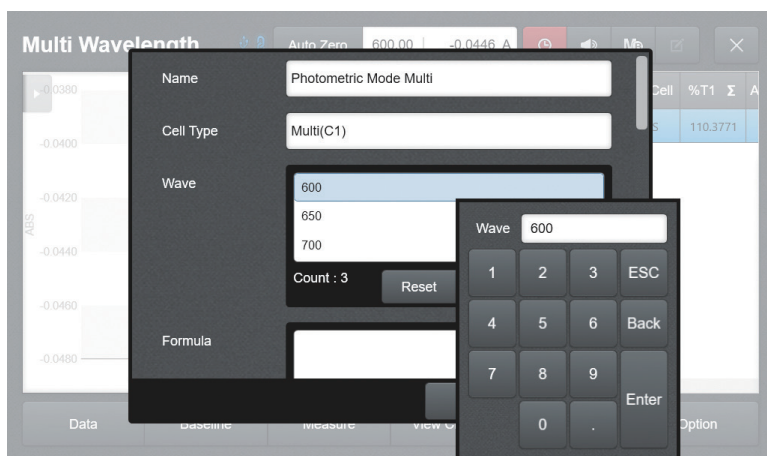

Fig. 3.8

1. Select the wavelength ① **Add** from the list on the settings screen.
2. [Fig. 3.8] Enter the wavelength to measure using the numeric keypad.
3. The scope of the wavelength can be 190-1100 nm, and the number can be entered to two decimal places (up to 8 numbers).

3-2-2 Formula Input

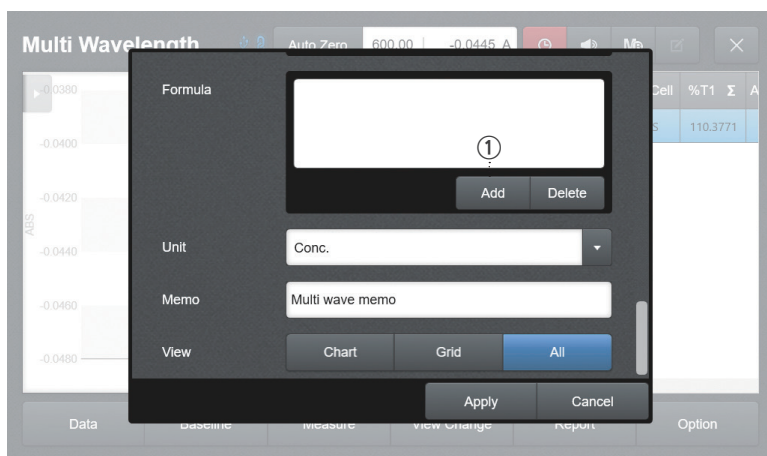

Fig. 3.9

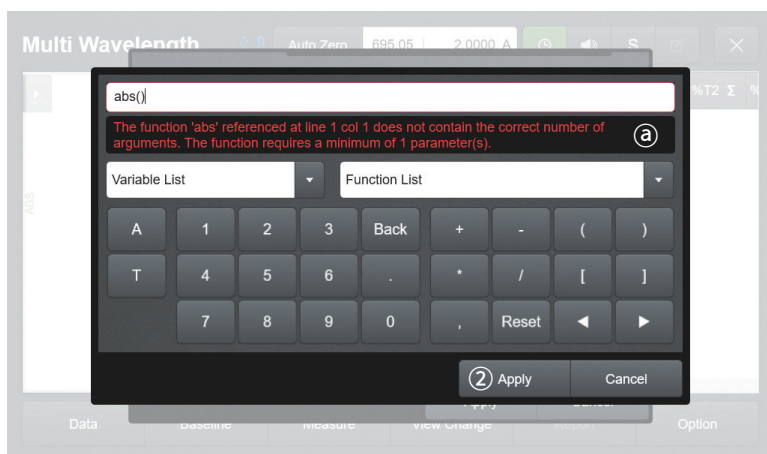

Fig. 3.10

1. Select the expression ① **Add** from the list on the settings screen.
2. [Fig. 3.10] Enter the expression using the numeric keyboard. * See 3-2-3, "Function list" on the next page.
3. Enter the expression and press ② **Apply** to finish.

i Note

- Variables are marked by starting and ending with "[" and "]" brackets.
 - The penetration ratio (T) and absorbance (A) can be entered in the variable list according to the number of wavelengths entered by the user.
- * If the formula has been entered incorrectly, an error message will be displayed in the @ column.

3-2-3 Function List

The function list includes frequently-used functions as follows.

Name	Description	Minimum input factor	Maximum input factor
abs	Returns the absolute value of a number. The absolute value of a number is the number without its sign.	1	1
acos	Returns the arccosine, or inverse cosine, of a number. The arccosine is the angle whose cosine is specified number. The returned angle is given in radians in the range zero to pi. To convert the result from radians to degrees, multiply by 180/PI().	1	1
acosh	Returns the inverse hyperbolic cosine of the given number. The inverse hyperbolic cosine is the angle whose hyperbolic cosine is specified number.	1	1
asin	Returns the arcsine, or inverse sine, of a number. The arcsine is the angle whose sine is the specified number. The returned angle is given in radians in the range $-\pi/2$ to $\pi/2$. To express the arcsine in degrees, multiply the result by 180/PI().	1	1
asinh	Returns the inverse hyperbolic sine of the given number. The inverse hyperbolic sine is the angle whose hyperbolic sine is specified number.	1	1
atan	Returns the arctangent, or inverse tangent, of a number. The arctangent is the angle whose tangent is the specified number. The returned angle is given in radians in the range $-\pi/2$ to $\pi/2$. To express the arctangent in degrees, multiply the result by 180/PI().	1	1
atan2	Returns the arctangent, or inverse tangent, of the specified x and y-coordinates. The arctangent is the angle from the x-axis to a line containing the origin (0, 0) and a point with coordinates (x_num, y_num). The angle is given in radians between $-\pi$ and π , excluding $-\pi$.	2	2
atanh	Returns the inverse hyperbolic tangent of the given number. The inverse hyperbolic tangent is the angle whose hyperbolic tangent is specified number.	1	1
ceiling	Returns the smallest multiple of the significance (defaults to 1) greater than or equal to the specified number.	1	2
combin	Returns the number of possible combinations given a set of items and a number of chosen items from that set.	2	2

Name	Description	Minimum input factor	Maximum input factor
comбина	Returns the number of possible combinations (with repetitions) given a set of items and a number of chosen items from that set.	2	2
cos	Returns the cosine of the given angle.	1	1
cosh	Returns the hyperbolic cosine of a number.	1	1
degrees	Converts radians to degrees.	1	1
even	Rounds a positive number up and a negative number down to nearest even integer.	1	1
exp	Returns e raised to the power of the specified number. The constant e equals 2.71828182845904.	1	1
fact	Returns the factorial of a number.	1	1
factdouble	Returns the double factorial of a number.	1	1
floor	Returns the largest multiple of the significance (defaults to 1) less than or equal to the given number.	1	2
gcd	Returns the greatest common divisor of one or more integer values.	1	2147483647
int	Rounds a number down to the nearest integer.	1	1
lcm	Returns the least common multiple of one or more integer values.	1	2147483647
ln	Returns the natural logarithm of a number.	1	1
log	Returns the logarithm of a number to the base specified.	1	2
log10	Returns the base-10 logarithm of a number.	1	1
mod	Returns the remainder after a number is divided by a divisor. The result has the same sign as the divisor.	2	2
mround	Rounds a number to the nearest multiple of another number.	2	2
multinomial	Returns the multinomial of a set of numbers. The multinomial is the ratio of the factorial of a sum of values to the product of their factorials.	1	2147483647
odd	Rounds a positive number up and a negative number down to the nearest odd integer.	1	1

Name	Description	Minimum input factor	Maximum input factor
pi	Returns the constant pi, which is 3.14159265358979.	0	0
power	Returns the result of a number raised to a power.	2	2
product	Multiplies all the numbers given as arguments and returns the product.	1	2147483647
quotient	Returns the integer portion of a division. This will discard the remainder of the division.	2	2
radians	Converts degrees to radians.	1	1
round	Rounds a number to a specified number of digits.	2	3
rounddown	Rounds a number to down to the specified number of digits.	2	2
roundup	Rounds a number to up to the specified number of digits.	2	2
seriesum	Returns the sum of a power series.	4	4
sign	Returns the sign of a number (-1, 0, or 1).	1	1
sin	Returns the sine of the specified angle.	1	1
sinh	Returns the hyperbolic sine of a number.	1	1
sqrt	Returns a positive square root of a number.	1	1
sqrtpi	Multiplies the specified number by pi and returns the square root of the result.	1	1
subtotal	Calculates the subtotal in one of more references.	2	2147483647
sum	Sums all the numbers given as arguments and returns the sum.	1	2147483647
tan	Returns the tangent of the specified angle.	1	1
tanh	Returns the hyperbolic tangent of the specified angle.	1	1
trunc	Truncates a number to an integer by removing the fractional part of the number.	1	2

3-2-4 Unit setting



Fig. 3.11

1. [Fig. 3.9] Select the unit item from the list on the settings screen.
2. [Fig. 3.11] Select a unit to use.

3-3 Report

Change the report layout to landscape or portrait and print out the report after preview.

Ch.3

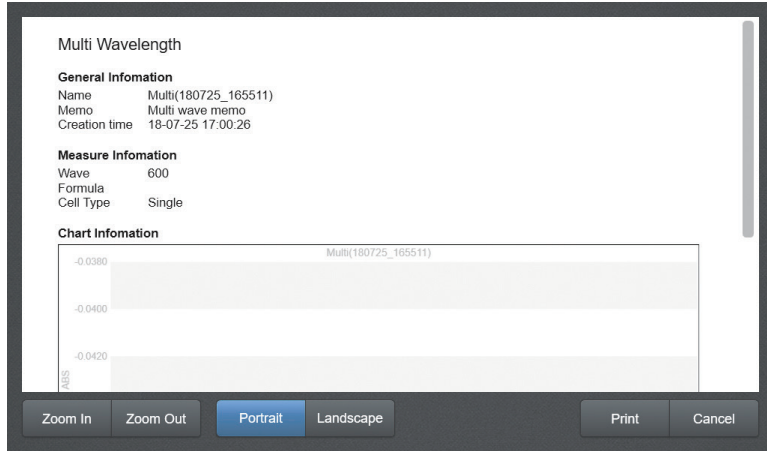

Fig. 3.12

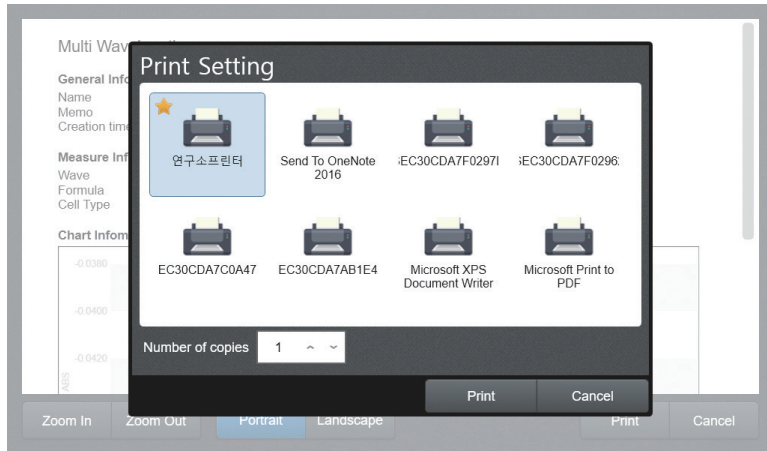

Fig. 3.13

Detailed Description

Name	Description
Zoom In/Out	Zoom in or out on printing details. *Not applied to printing
Portrait	Changes the printing page to vertical orientation.
Landscape	Changes the printing page to horizontal orientation.
Print	Select a printer. *Refer to Chapter 7, 7-8 "Printer settings" for more information on adding a printer.
Print	Print

3-4 Using Mode

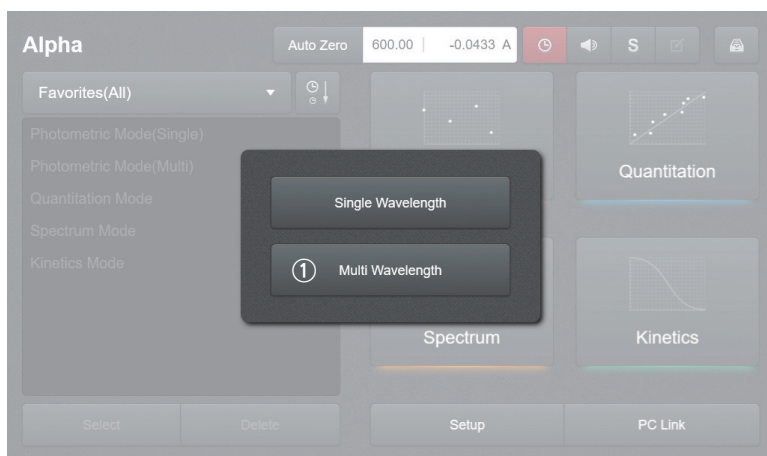

Fig. 3.14

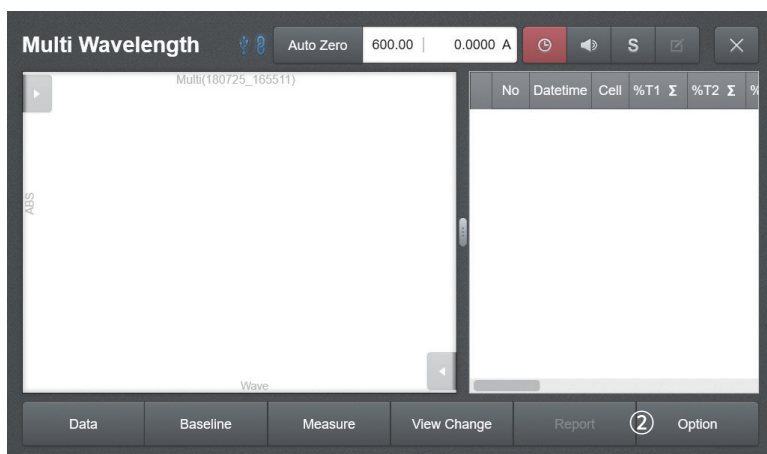

Fig. 3.15

1. [Fig. 3.14] Select ① **Multi Wavelength** Mode on the main page.
2. [Fig. 3.15] Move to the ② **Option** and specify the measurement settings.

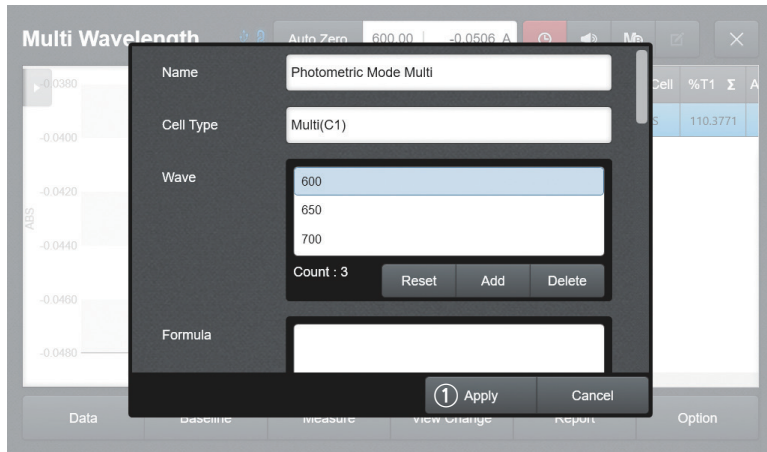

Fig. 3.16

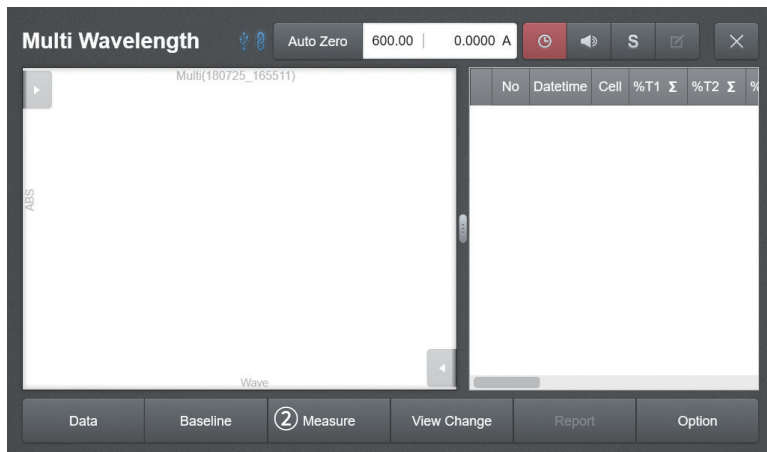

Fig. 3.17

3. [Fig. 3.16] Select and enter the Name, Cell Type, Wavelength, Factor, Formula, Unit, Memo and View Change, then press ① **Apply**
4. [Fig. 3.17] Insert the sample into the pertinent cell holder and press ② **Measure** to take measurements.
5. [Fig. 3.17] If there a sample to add, insert a sample to measure into the pertinent cell holder and press ② **Measure** to take measurements.
6. You can check the measurement data in the table.

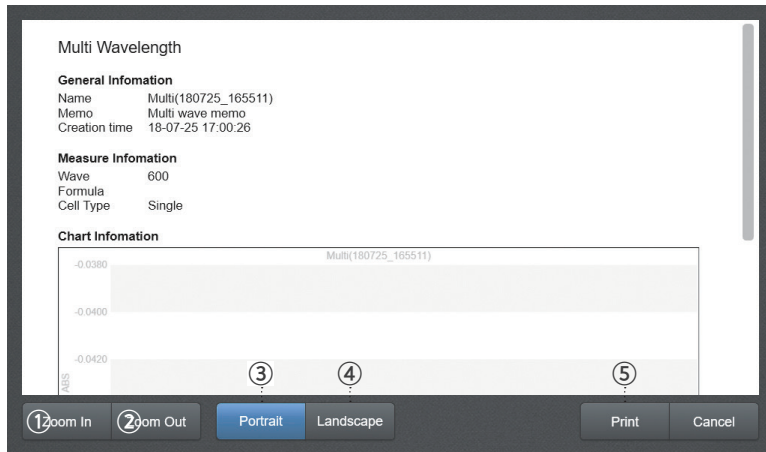

Fig. 3.18

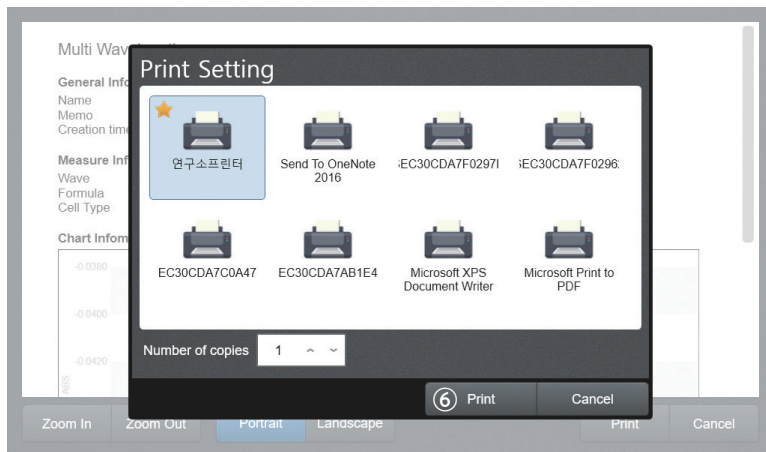

Fig. 3.19

7. Click [Figure 3.17] **Report** to check or print the measurement data in report form.
8. [Fig. 3.18] You can zoom in or out on the printing details using the ① **Zoom In** or ② **Zoom Out** buttons.
9. [Fig. 3.18] You can check or print in landscape or portrait mode using the ③ **Portrait** and ④ **Landscape** buttons.
10. [Fig. 3.18] Check the details to print and press the ⑤ **Print** button to open the print settings screen.
11. [Fig. 3.19] Set the printer and number of pages to print on the printer settings screen.
12. [Fig. 3.19] Press the ⑥ **Print** button to start printing.

This page is intentionally left blank.

Ch. 4

Quantitation Mode

- 4-1 Description of Quantitation Mode
 - 4-1-1 Calibration Curve Manager
- 4-2 File Import/Export
- 4-3 Standard Curve
 - 4-3-1 Standard Curve Mode
 - 4-3-2 Setting
 - 4-3-3 Unit Setting
- 4-3 Quantitation
- 4-4 Report
- 4-5 Using Mode (Standard Curve Generation)

4-1 Description of Quantitation Mode

The mode measures the absorbance of a standard specimen with known concentration to create the standard curve. You can measure the concentration by applying the standard curve to Quantitation Mode.

4-2-1 Calibration Curve Manager

Perform various functions such as selecting, creating, modifying, or deleting a standard curve, or importing or exporting an external standard curve file from external storage space.

Ch.4

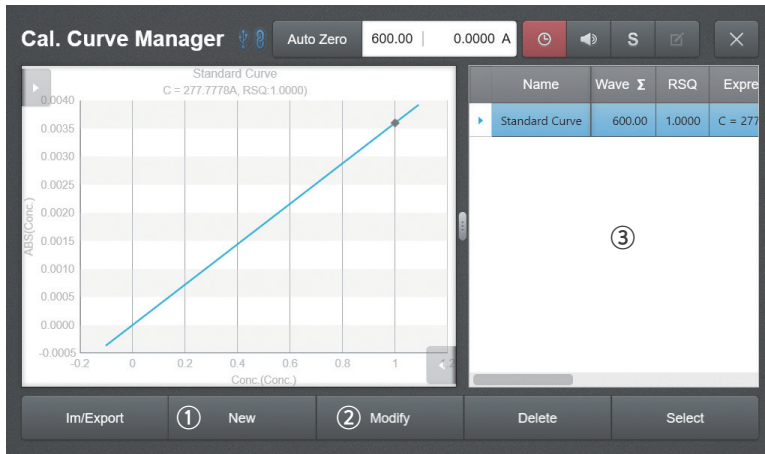

Fig. 4.1

Press ① 새로만들기 or ② 수정 to create a new standard curve or to modify a curve.

* Check the information (graph, RSQ value, calibration formula, etc.) when selecting a standard curve in the ③ list.

* Use the Import, Export, Delete, or Select tool after selecting a standard curve in the ③ list.

Name	Description
Import	Imports the standard curve file stored in the external storage unit into the list.
Export	Exports the stored standard curve file to the external storage unit.
New	Creates a new standard curve.
Modify	Checks and modifies the stored standard curve.
Delete	Deletes the checked standard curve.
Select	Applies the selected calibration curve to Quantitation Mode.

4-2 File Import/Export

File Import

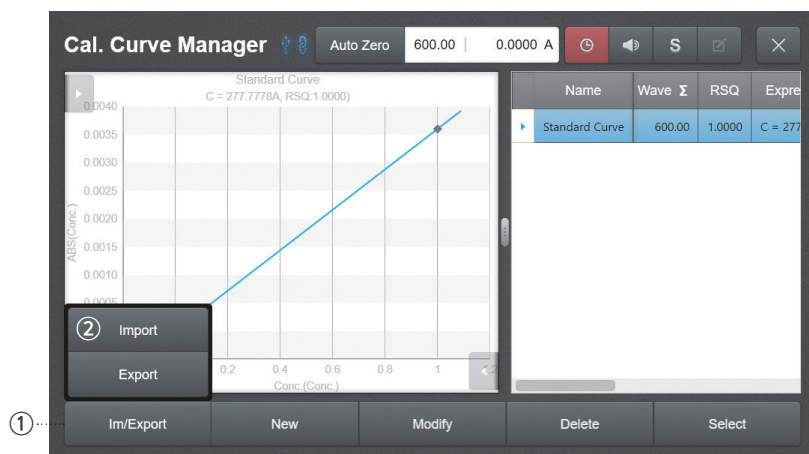

Fig. 4.2

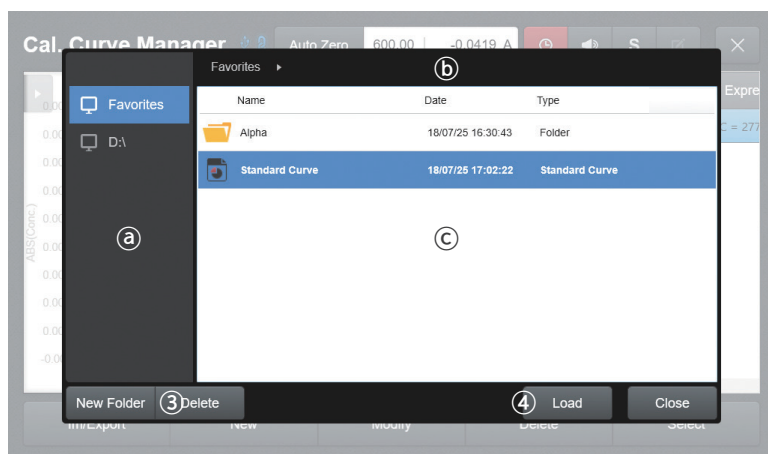

Fig. 4.3 (a) Drive list / (c) Data in pertaining drive / (b) Current folder location

1. Press ② **Import** in the list that appears after selecting ① **Im/Export**
2. Select a drive to read from the (a) list.
3. Select data to read from the (c) list.
4. Select the previous folder name in (b) to return to the previous folder.
5. Press ④ **Load** and read the file.
6. To delete a file, press ③ **Delete**

File Export

Ch.4

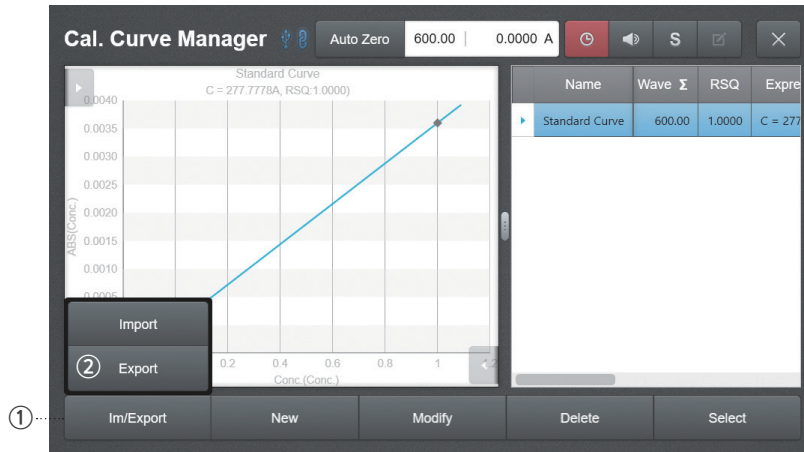

Fig. 4.4

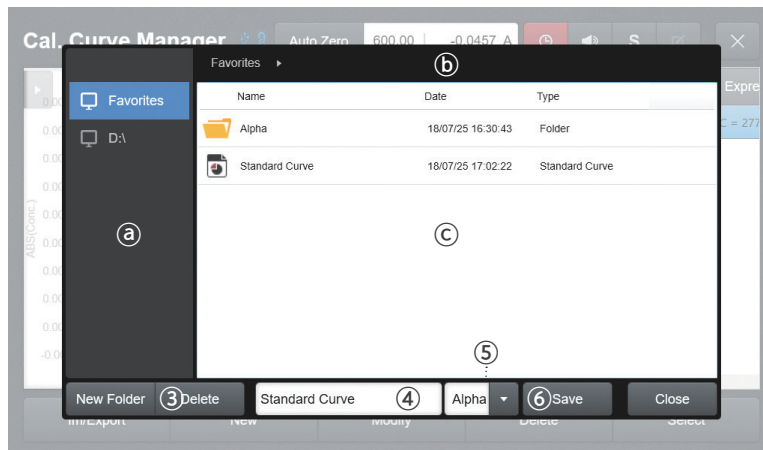

Fig. 4.5 (a) Drive list / (c) Data in pertaining drive / (b) Current folder location

1. Press ② **Export** in the list that appears after selecting ① **Im/Export**
2. Select a drive to save from the (a) list.
3. Enter the name of data to save in ④. * If the file is overwritten, a warning window will be displayed.
4. ⑤ Specify the file format. (Supported file extensions: Alpha, CSV, Excel, TXT)
5. Press ⑥ **Save** to save the file.
6. To delete a file, press ③ **Delete**

4-3 Standard Curve

4-3-1 Standard Curve Mode

Enter the concentrations of specimens in order and make the measurement to create the standard curve.

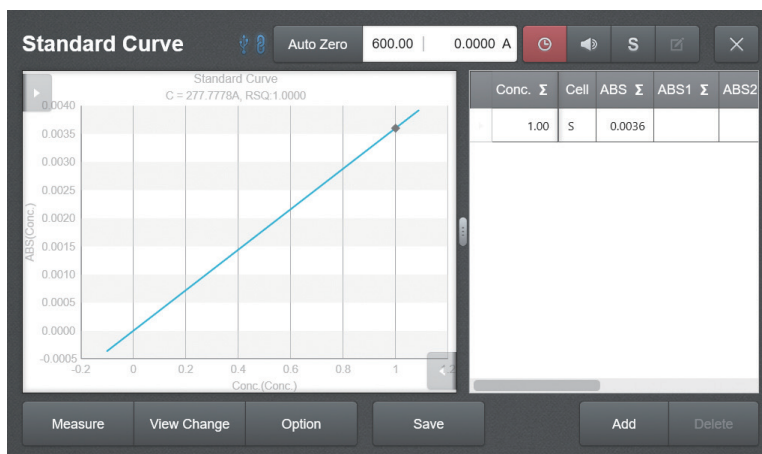

Fig. 4.6

Detailed Description

Name	Description
Measure	Input a measurement sample and take measurements.
View Change	Display the measurement result in a form of graph, data, or graph and data.
Option	Set default measurement items.
Save	Creates a standard curve by applying the measurement data after taking measurements.
Add	Enter the density of the pertinent cell.
Delete	Deletes the selected data.

Ch.4

4-3-2 Setting

You can specify the Name, Cell Type, Wavelength, Calibration Type, Times, Unit, Memo, and View Change.

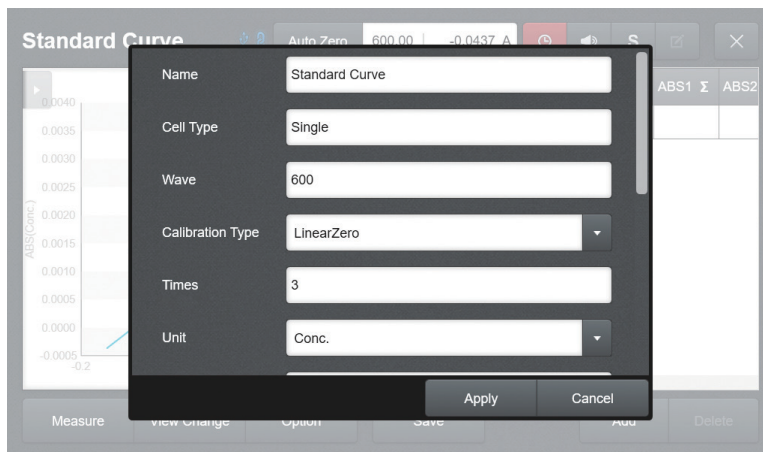

Fig. 4.7

List of Settings

Name	Description	Detailed Description
Name	Specifies the name of the measured data.	
Cell Type	Selects the cell type to be used.	* Refer to 8-1 Cell Type Settings in Ch. 8
Wavelength	Specifies the wavelength to be used.	Operating range: 190 - 1100 nm
Cal. Type	Select a standard curve type.	LinearZero, Linear, Quadratic, Cubic
Times	Enter the number of measurements for each sample.	Up to 5 times.
Unit	Selects the unit to be used.	
Memo	Enters the memo if needed.	
View Change	Display the measurement result in a form of graph, data, or graph and data.	

4-3-3 Unit setting



Fig. 4.8

1. [Fig. 4.7] Select the unit item from the list on the settings screen.
2. [Fig. 4.8] Select a unit to use.

4-3 Quantitation

Enter the concentrations of specimens in order and make the measurement to create the standard curve.

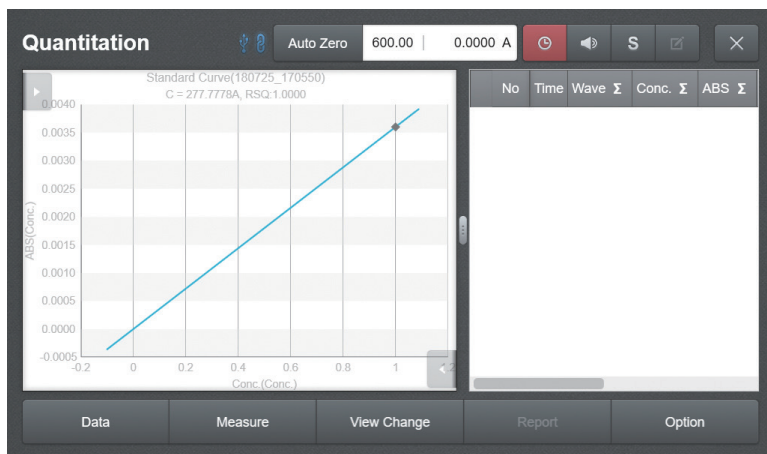

Fig. 4.9

Detailed Description

Name	Description
Data	Manage the measurement data (read, save, batch delete).
Measure	Input a measurement sample and take measurements.
View Change	Display the measurement result in a form of graph, data, or graph and data.
Report	View or print the measurement result.
Option	Set default measurement items.

4-4 Report

Change the report layout to landscape or portrait and print out the report after preview.

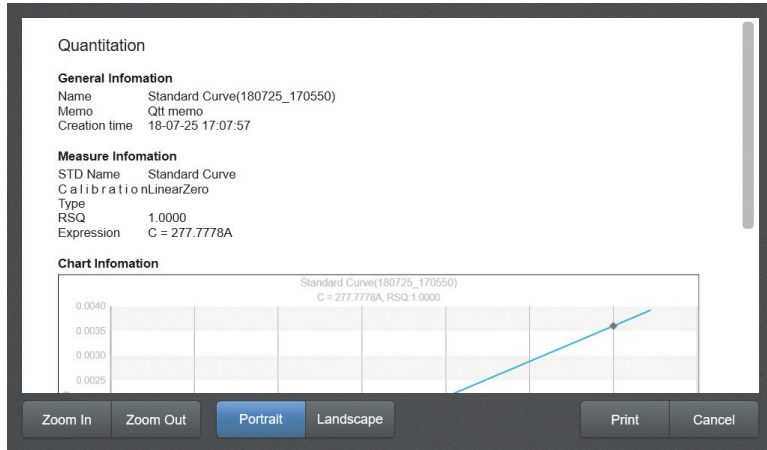

Fig. 4.10

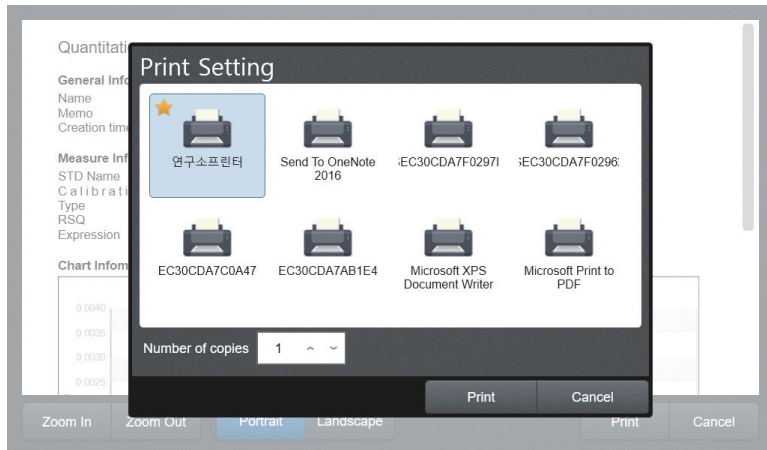

Fig. 4.11

Detailed Description

Name	Description
Zoom In/Out	Zoom in or out on printing details. *Not applied to printing
Portrait	Changes the printing page to vertical orientation.
Landscape	Changes the printing page to horizontal orientation.
Print	Select a printer. *Refer to Chapter 7, 7-8 "Printer settings" for more information on adding a printer.
Print	Print

4-5 Using Mode (Standard Curve Generation)

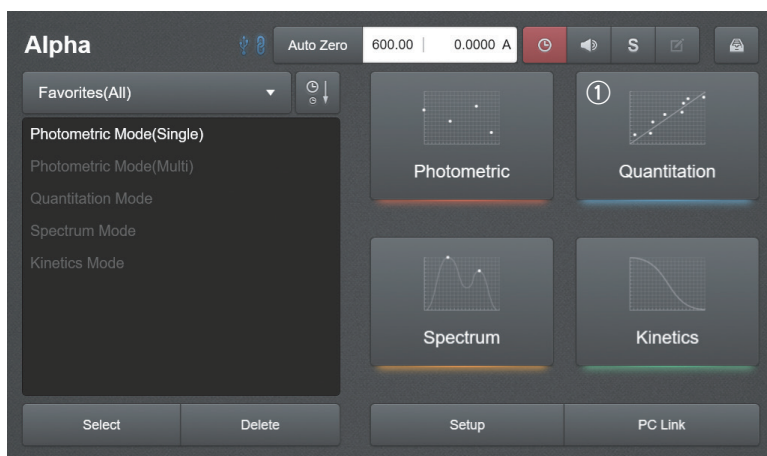

Fig. 4.12

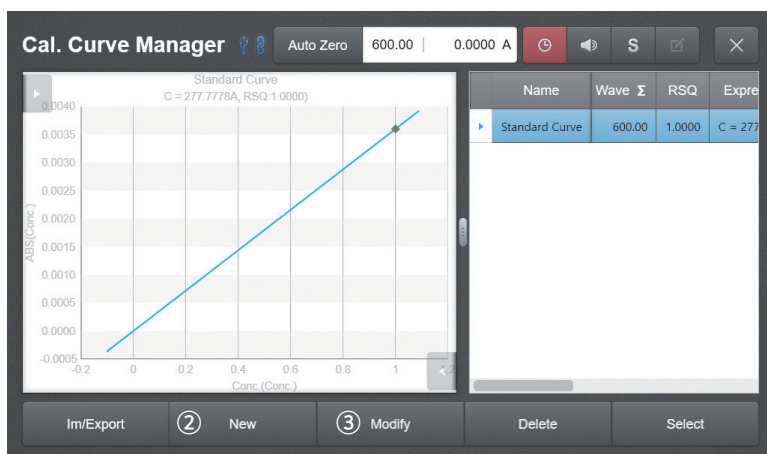

Fig. 4.13

1. [Fig. 4.12] Select ① **Quantitation Mode** on the main screen.
2. [Fig. 4.13] Standard curve mode will be displayed if ② **New** (creating a new standard curve) or ③ **Modify** (modifying an existing curve) is selected on the Calibration Curve Manager screen.

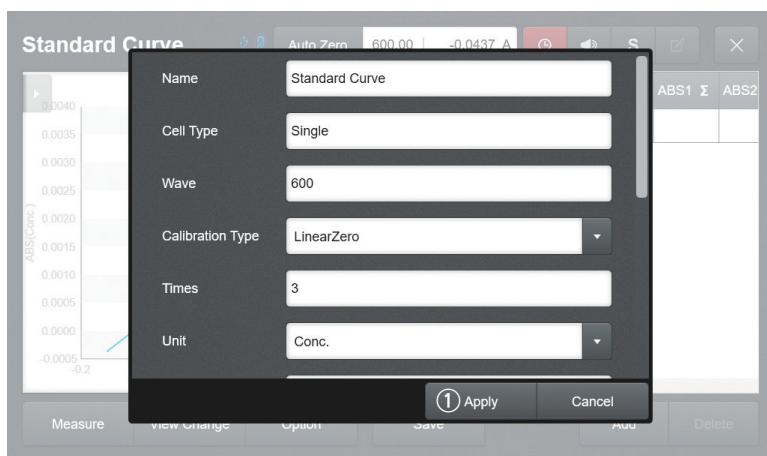

Fig. 4.14

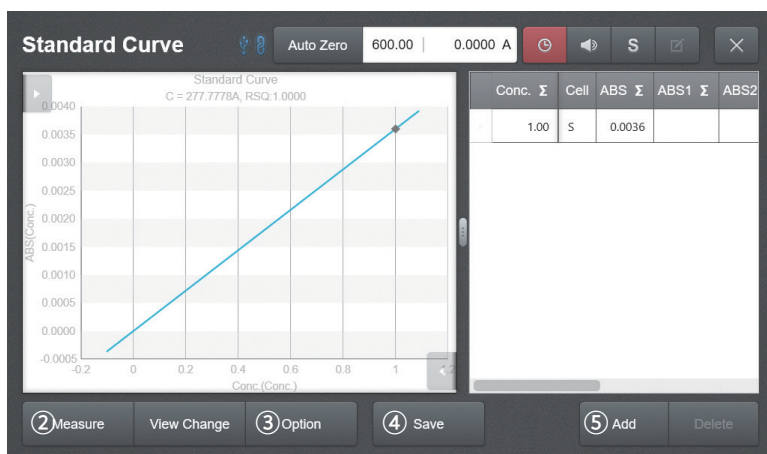

Fig. 4.15

3. [Fig. 4.15] Set the details for measurement by moving to ③ **Option** from standard curve mode.
4. [Fig. 4.14] Select and enter the Name, Cell Type, Wavelength, Calibration Type, Times, Unit, Memo, and View Change, then press ① **Apply**
5. [Fig. 4.14] Press the ⑤ **Add** button and enter the density of the standard sample.
6. [Fig. 4.15] Insert a sample to measure into the pertinent cell holder after entering the density, and take measurements by pressing ② **Measure**
7. [Fig. 4.15] If there a sample to add, insert the sample to measure into the pertinent cell holder and press ② **Measure** to take measurements.
8. Check the measurement data in the table.
9. [Fig. 4.15] If ④ **Save** is selected, a calibration curve with the selected standard curve type will be created, and the chart, calibration curve formula, and RSQ value can be checked.

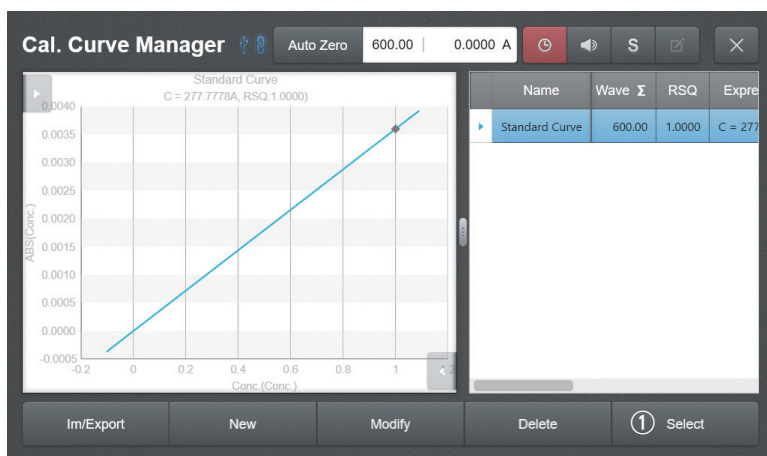

Fig. 4.16

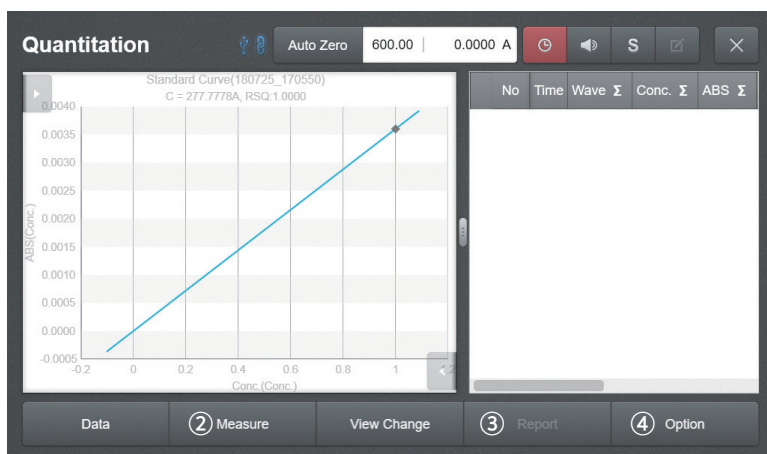

Fig. 4.17

10. [Fig. 4.16] Select the saved standard curve and press ① **Select** to enter Quantitation mode.
11. [Fig. 4.17] Click ④ **Option** to enter and apply the name, cell type, unit, dilution rate, and memo.
12. [Fig. 4.17] Press ② **Measure** and take measurements after setting the options.
13. [Fig. 4.17] Move to ③ **Report** to check or print the measurement data in report form.

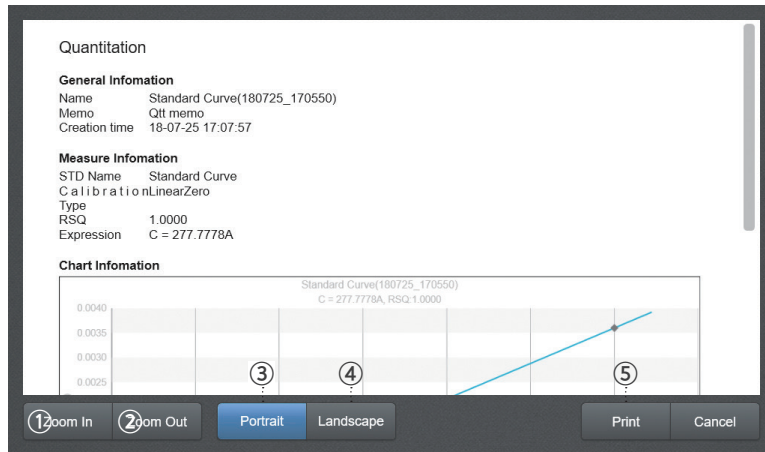

Fig. 4.18



Fig. 4.19

14. [Fig. 4.18] You can zoom in or out on the printing details using the ① **Zoom In** or ② **Zoom Out** buttons.
15. [Fig. 4.18] You can check or print in landscape or portrait mode using the ③ **Portrait** and ④ **Landscape** buttons.
16. [Fig. 4.18] Check the details to print and press the ⑤ **Print** button to open the print settings screen.
17. [Fig. 4.19] Set the printer and number of pages to print on the printer settings screen.
18. [Fig. 4.19] Press the ⑥ **Print** button to start printing.

This page is intentionally left blank.

Ch. 5

Spectrum Mode

5-1 Mode Main Page

5-2 File Load/Save

5-3 Setting

5-4 Report

5-5 Using Mode

Ch.5

5-1 Mode Main Page

This mode scans the selected cell of the specified wavelength band in the specified step interval and displays it in a chart or table form. It is used to search the absorbance and transmittance in each wavelength.

Measurement Screen

You can scan the selected cell of the specified wavelength band in the specified step interval.

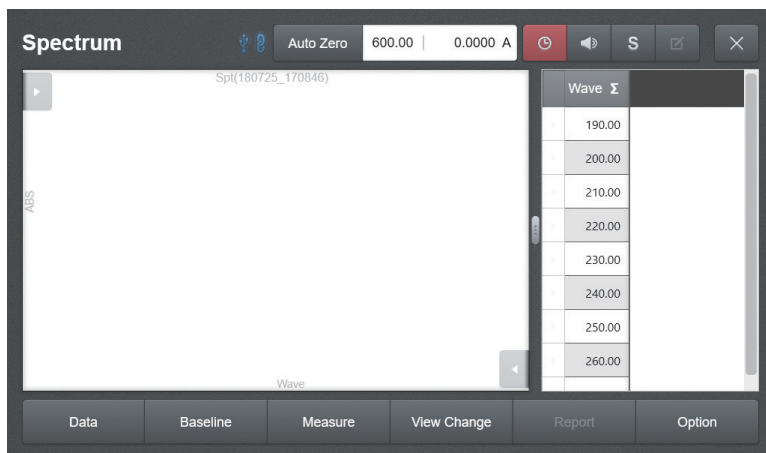

Fig. 5.1

Detailed Description

Name	Description
Data	Manage measurement data (read; save; delete all).
Measure	Input a measurement sample and take measurements.
View Change	Display the measurement result in a form of graph, data, or graph and data.
Report	View or print the measurement result.
Option	Set default measurement items.

5-2 File Load/Save

To Load File

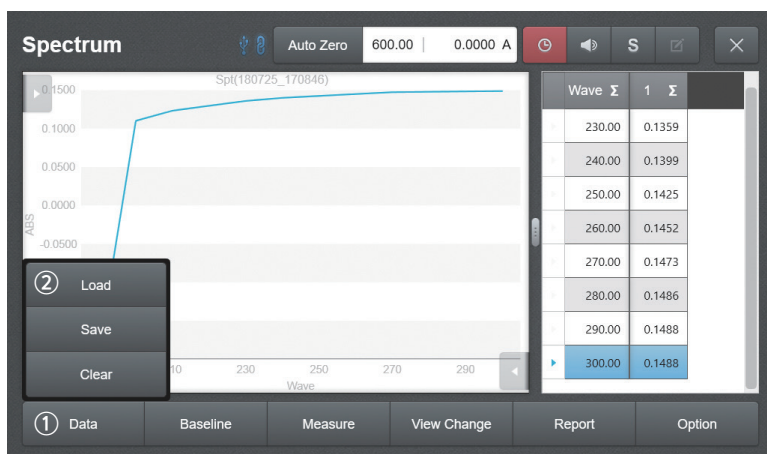

Fig. 5.2

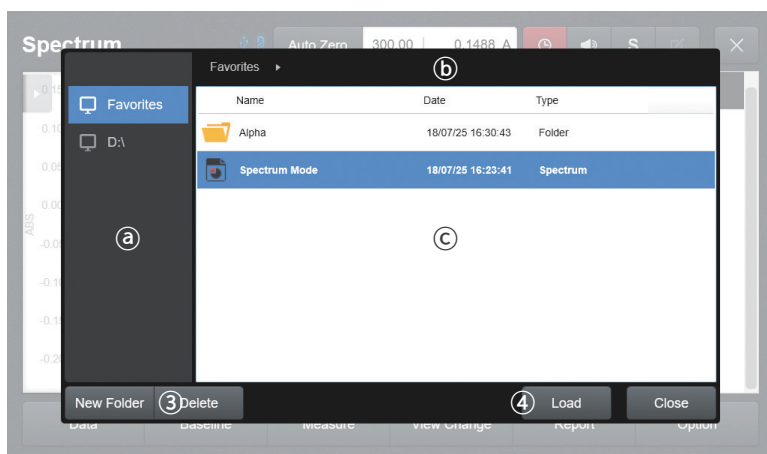

Fig. 5.3 a) Drive list / c) Data in pertaining drive / b) Current folder location

1. Press ② **Load** in the list that appears after selecting ① **Data**
2. Select a drive to read from the ③ list.
3. Select data to read from the ④ list.
4. Select the previous folder name in ⑤ to return to the previous folder.
5. Press ⑥ **Load** and read the file.
6. To delete a file, press ⑦ **Delete**

Ch.5

To Save File

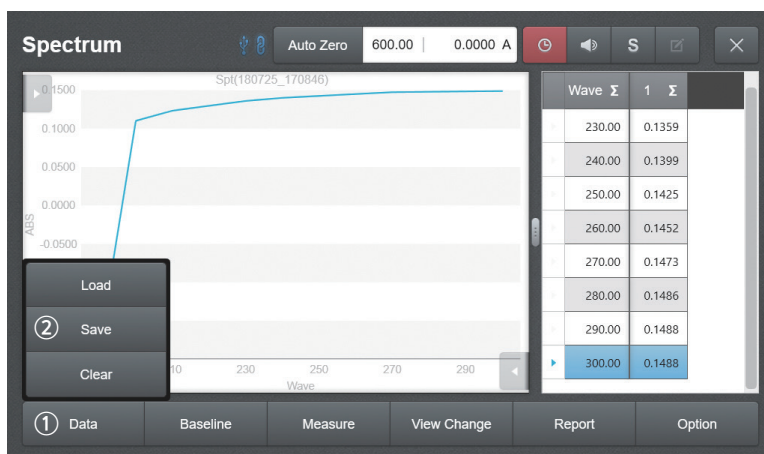

Fig. 5.4

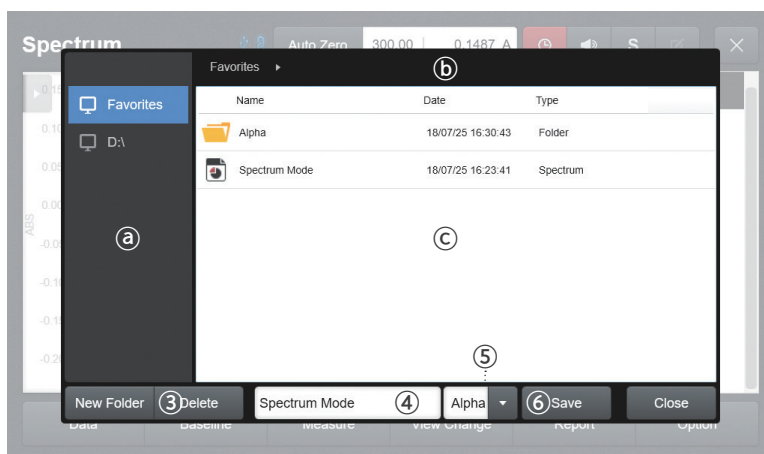

Fig. 5.5 (a) Drive list / (c) Data in pertaining drive / (b) Current folder location

1. Press ② **Save** in the list that appears after selecting ① **Data**
2. Select a drive to save from the (a) list.
3. Enter the name of data to save in ④. * If the file is overwritten, a warning window will be displayed.
4. ⑤ Specify the file format. (Supported file extensions: Alpha, CSV, Excel, TXT)
5. Press ⑥ **Save** to save the file.
6. To delete a file, press ③ **Delete**

5-3 Setting

This section describes the window for measurement settings.

You can specify the Name, Cell Type, Start Wavelength, End Wavelength, Interval, Speed, Peak/Valley Coefficient, Memo, and View Change.

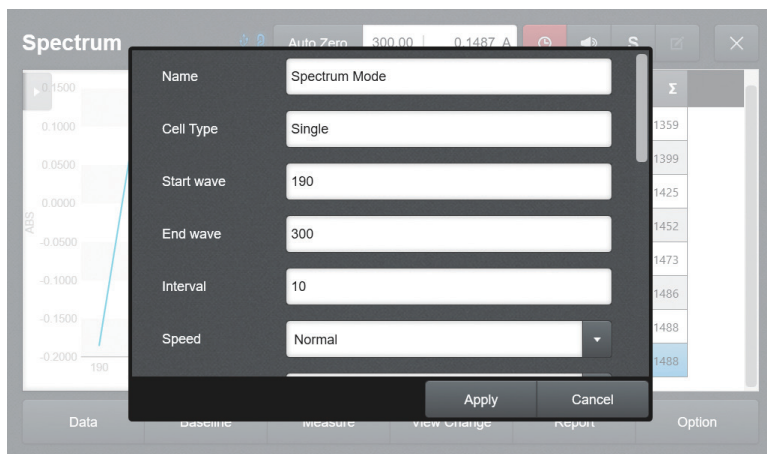

Fig. 5.6

List of Settings

Name	Description	Detailed Description
Name	Specifies the name of the measured data.	
Cell Type	Selects the cell type to be used.	* Refer to 8-1 Cell Type Settings in Ch. 8
Start Wavelength	Specifies the wavelength to begin scanning.	Operating range: 190 - 1100 nm
End Wavelength	Specifies the wavelength to end scanning.	Operating range: 190 - 1100 nm
Interval	Specifies the scan wavelength interval.	
Speed	Selects the scan speed.	You can select a speed as follows. * Very slow, slow, normal, fast, very fast
Peak/Valley Coefficient	Modifies the peak/valley settings condition.	
Memo	Enters the memo if needed.	
View Change	Display the measurement result in a form of graph, data, or graph and data.	

5-4 Report

Change the report layout to landscape or portrait and print out the report after preview.

Ch.5

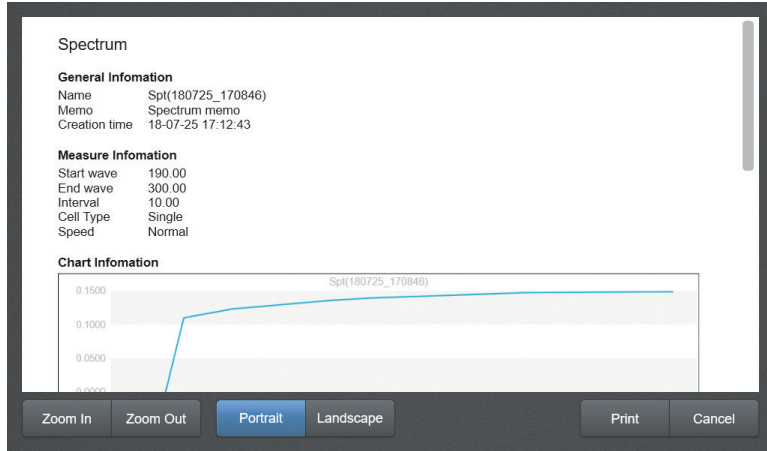

Fig. 5.7

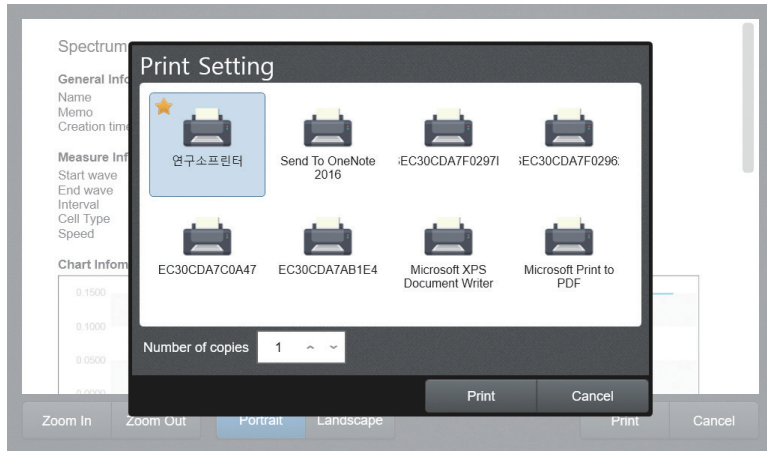

Fig. 5.8

Detailed Description

Name	Description
Zoom In/Out	Zoom in or out on printing details. *Not applied to printing
Portrait	Changes the printing page to vertical orientation.
Landscape	Changes the printing page to horizontal orientation.
Print	Select a printer. *Refer to Chapter 7, 7-8 "Printer settings" for more information on adding a printer.
Print	Print

5-5 Using Mode

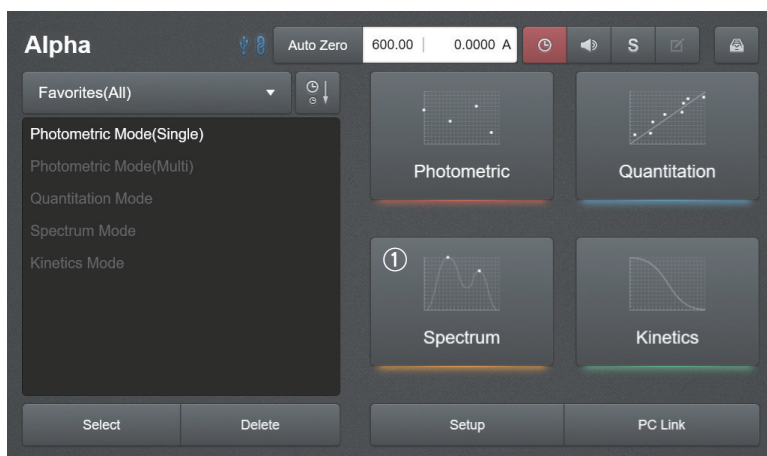

Fig. 5.9

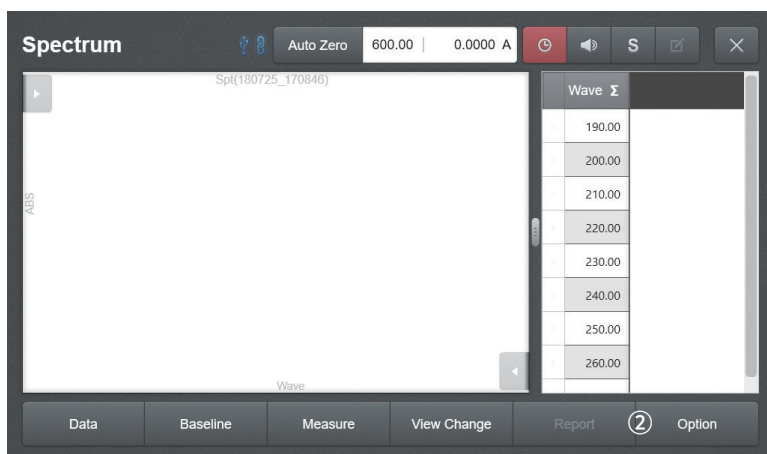

Fig. 5.10

1. [Fig. 5.9] Select ① **Spectrum Mode** Mode on the main page.
2. [Fig. 5.10] Move to the ② **Option** and specify the measurement settings.

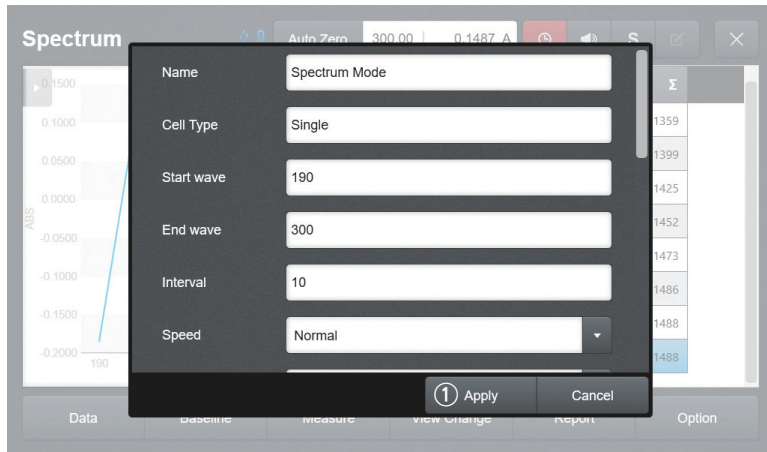

Fig. 5.11

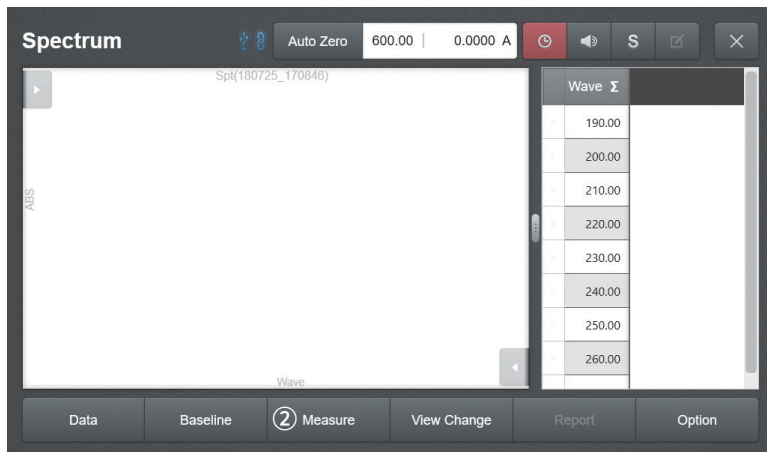

Fig. 5.12

3. [Fig. 5.11] Select and enter the Name, Cell Type, Start Wavelength, End Wavelength, Interval, Speed, Peak/Valley Coefficient, Memo, and View Change, then press ① **Apply**
4. [Fig. 5.12] Insert the sample into the pertinent cell holder and press ② **Measure** to take measurements.
5. [Fig. 5.12] If there a sample to add, insert a sample to measure into the pertinent cell holder and press ② **Measure** to take measurements.
6. You can check the measurement data in the table.

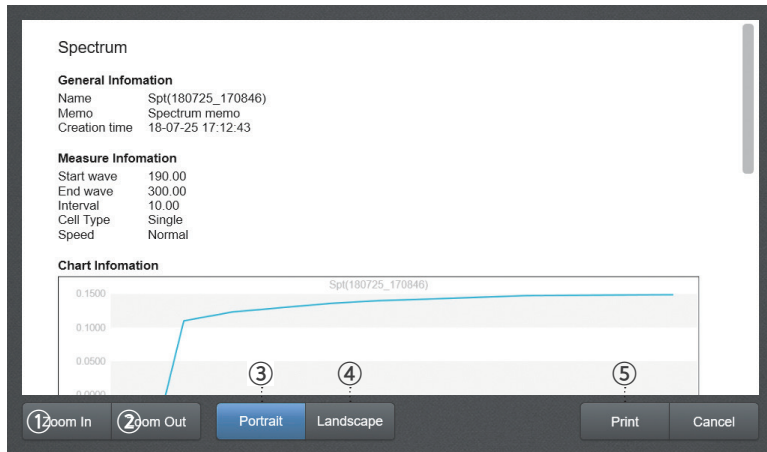

Fig. 5.13

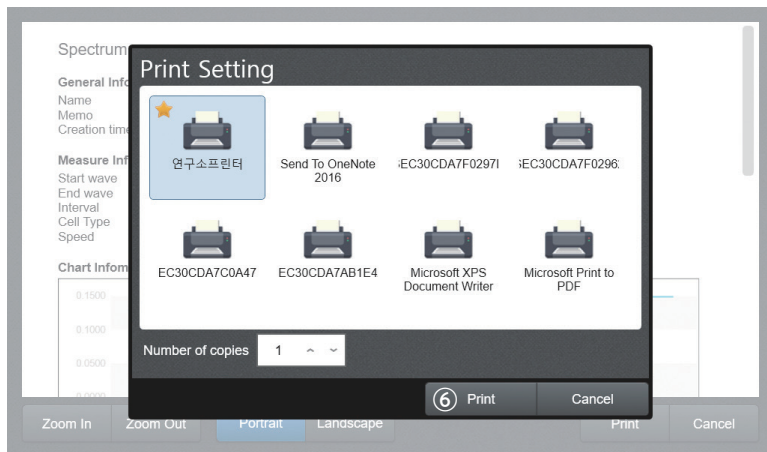

Fig. 5.14

7. Click [Figure 5.12] **Report** to check or print the measurement data in report form.
8. [Fig. 5.13] You can zoom in or out on the printing details using the ① **Zoom In** or ② **Zoom Out** buttons.
9. [Fig. 5.13] You can check or print in landscape or portrait mode using the ③ **Portrait** and ④ **Landscape** buttons.
10. [Fig. 5.13] Check the details to print and press the ⑤ **Print** button to open the print settings screen.
11. [Fig. 5.14] Set the printer and number of pages to print on the printer settings screen.
12. [Fig. 5.14] Press the ⑥ **Print** button to start printing.

This page is intentionally left blank.

Ch. 6

Kinetics Mode

6-1 Description of Kinetics Mode

6-2 File Load/Save

6-3 Setting

6-4 Report

6-5 Using Mode

6-1 Description of Kinetics Mode

The mode shows the concentration change of specimen with time.

It is convenient for measuring the currently reacting specimen. The measured data are available in a chart or table form.

Measurement Page

You can measure the concentration change of specimen with time.

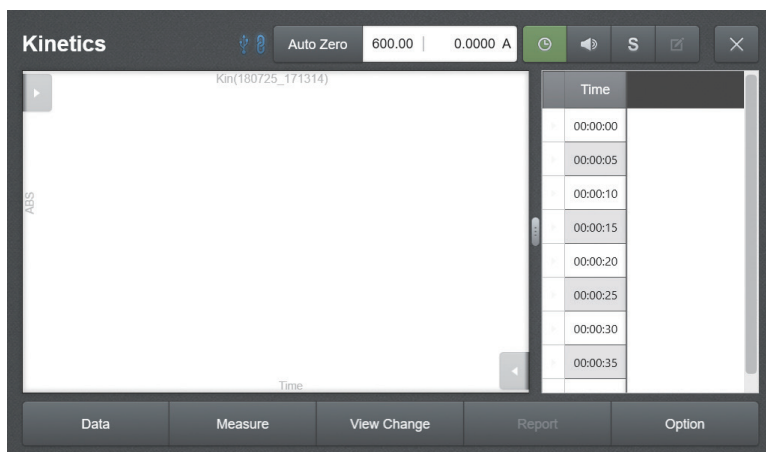

Fig. 5.1

Detailed Description

Name	Description
Data	Manage measurement data (read; save; delete all).
Measure	Input a measurement sample and take measurements.
View Change	Display the measurement result in a form of graph, data, or graph and data.
Report	View or print the measurement result.
Option	Set default measurement items.

6-2 File Load/Save

To Load File

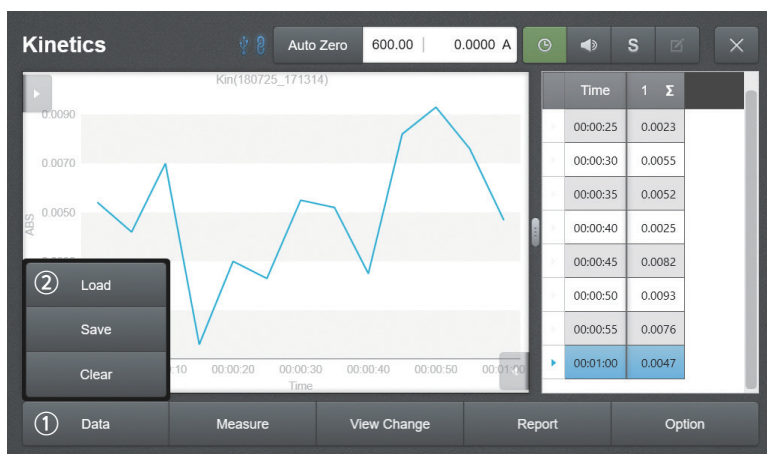

Fig. 6.2

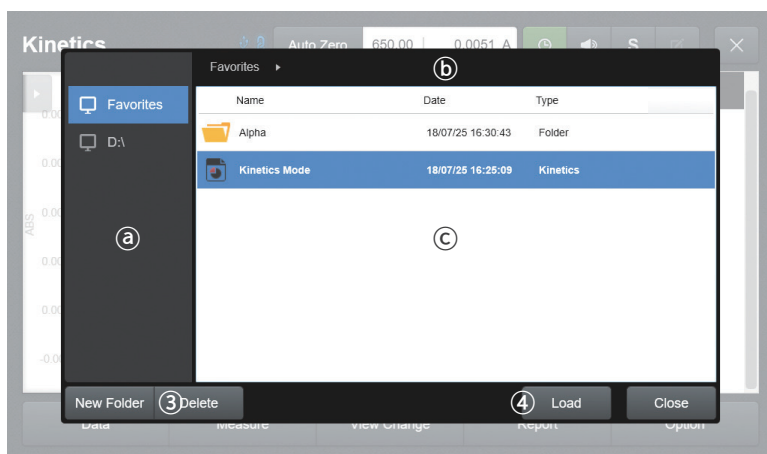

Fig. 6.3 (a) Drive list / (c) Data in pertaining drive / (b) Current folder location

1. Press ② **Load** in the list that appears after selecting ① **Data**
2. Select a drive to read from the (a) list.
3. Select data to read from the (c) list.
4. Select the previous folder name in (b) to return to the previous folder.
5. Press ④ **Load** and read the file.
6. To delete a file, press ③ **Delete**

To Save File

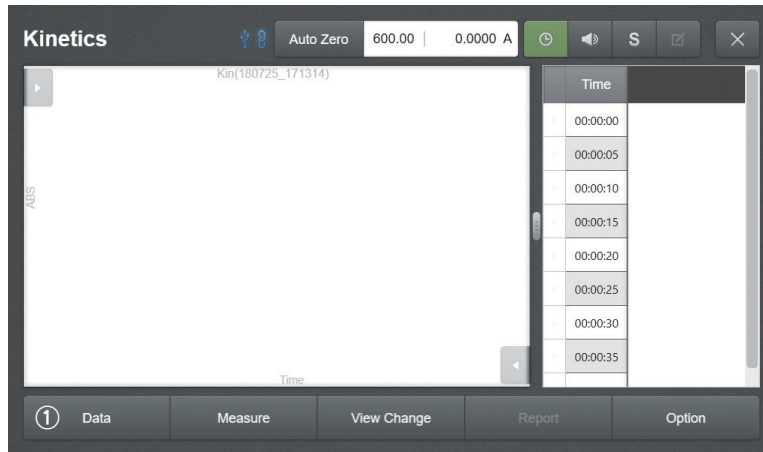

Fig. 6.4

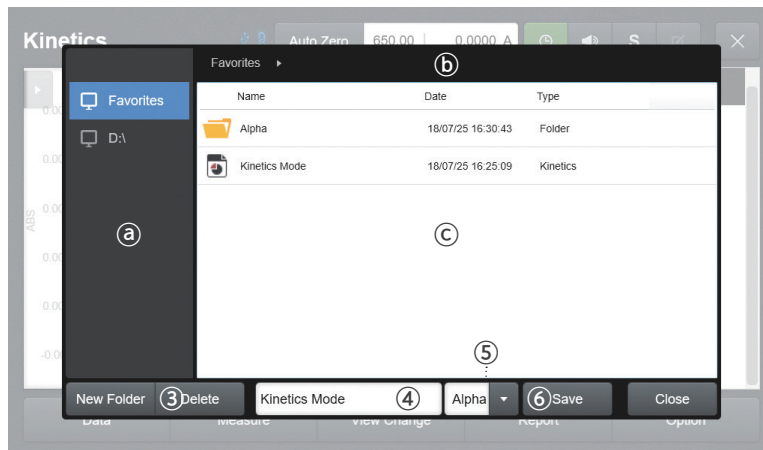

Fig. 6.5 (a) Drive list / (c) Data in pertaining drive / (b) Current folder location

1. Press ② **Save** in the list that appears after selecting ① **Data**
2. Select a drive to save from the (a) list.
3. Enter the name of data to save in ④. * If the file is overwritten, a warning window will be displayed.
4. ⑤ Specify the file format. (Supported file extensions: Alpha, CSV, Excel, TXT)
5. Press ⑥ **Save** to save the file.
6. To delete a file, press ③ **Delete**

6-3 Setting

Specifies the measurement settings.

Specifies the Name, Cell Type, Wavelength, Total time, Time interval, Memo, and View Change.

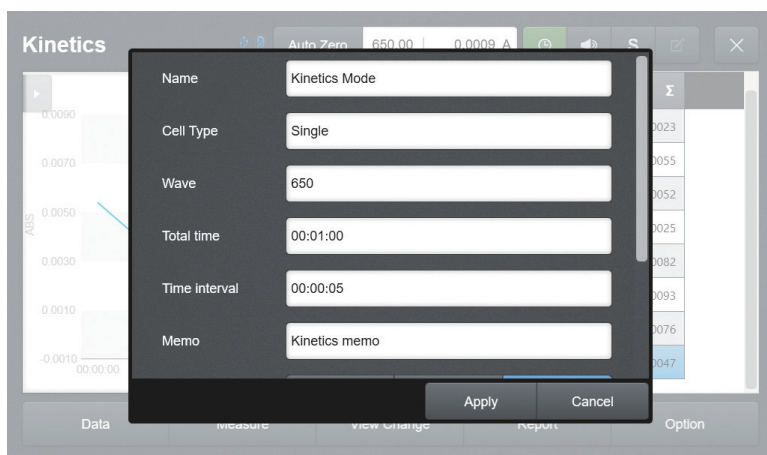

Fig. 6.6

List of Settings

Name	Description	Detailed Description
Name	Specifies the name of the measured data.	
Cell Type	Selects the cell type to be used.	* Refer to 8-1 Cell Type Settings in Ch. 8
Wavelength	Specifies the wavelength to be used.	Operating range: 190 - 1100 nm
Total time	Specifies the total measurement time.	Operating range: 190 - 1100 nm
Time interval	Specifies the scan wavelength interval.	
Memo	Enters the memo if needed.	
View Change	Display the measurement result in a form of graph, data, or graph and data.	

6-4 Report

Change the report layout to landscape or portrait and print out the report after preview.



그림 6.7



그림 6.8

Detailed Description

Name	Description
Zoom In/Out	Zoom in or out on printing details. *Not applied to printing
Portrait	Changes the printing page to vertical orientation.
Landscape	Changes the printing page to horizontal orientation.
Print	Select a printer. *Refer to Chapter 7, 7-8 "Printer settings" for more information on adding a printer.
Print	Print

6-5 Using Mode

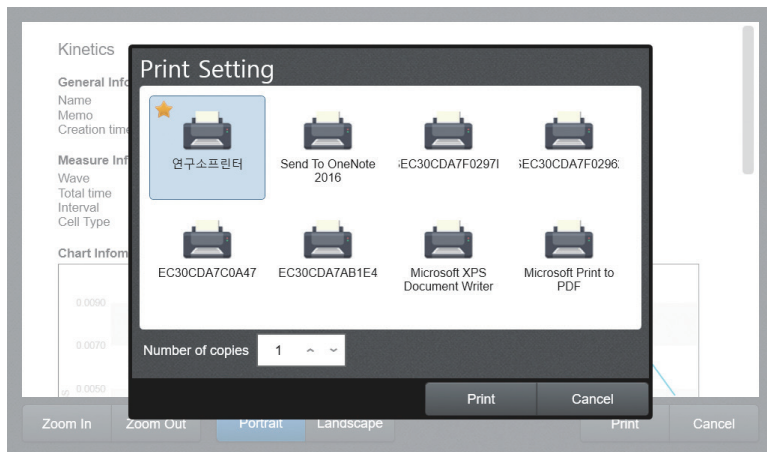
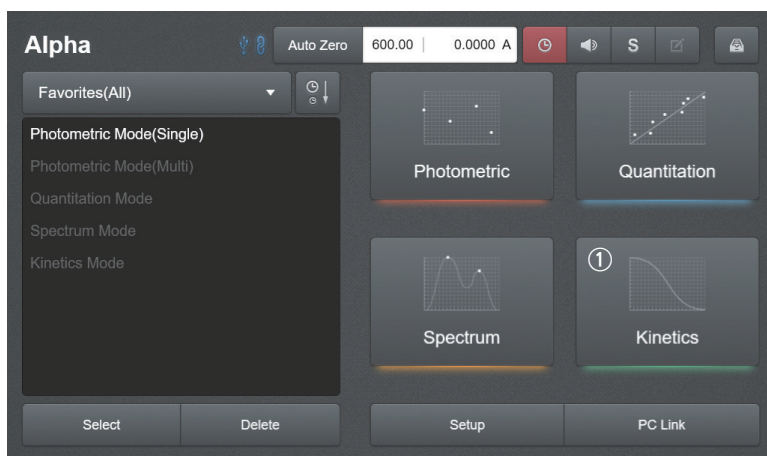

Fig. 6.9

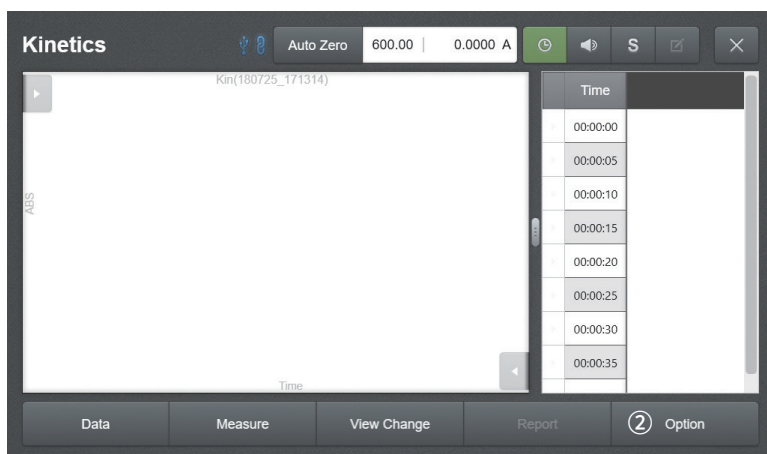

Fig. 6.10

1. [Fig. 6.9] Select ① **Kinetics Mode** Mode on the main page.
2. [Fig. 6.10] Move to the ② **Option** and specify the measurement settings.

Ch.6

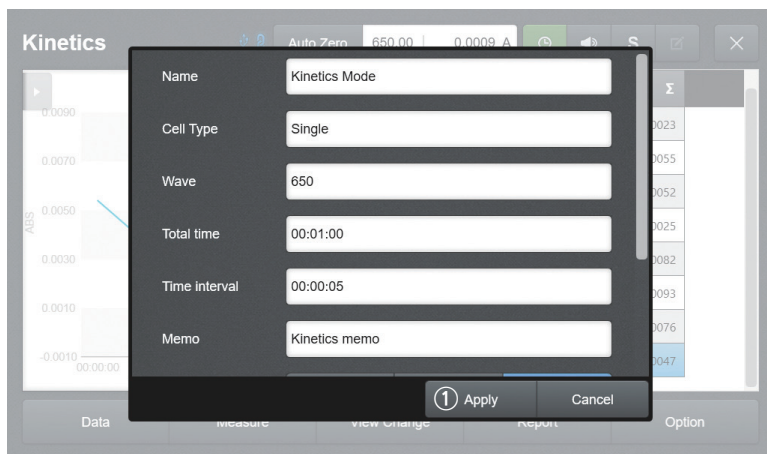

Fig. 6.11

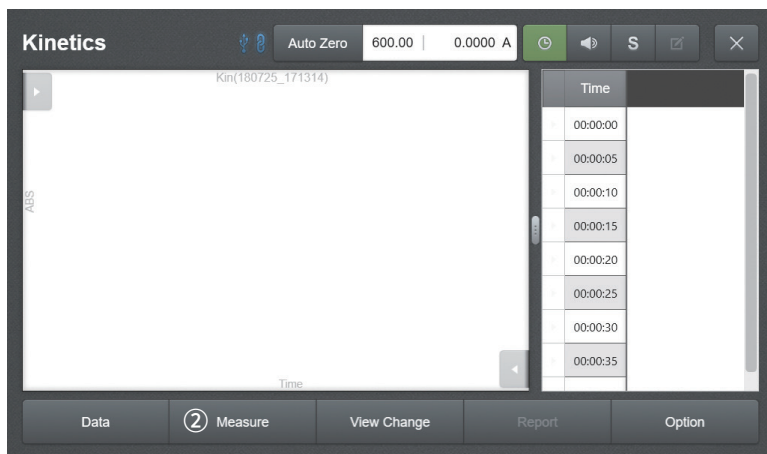

Fig. 6.12

3. [Fig. 6.11] Select and enter the Name, Cell Type, Wavelength, Total time, Time interval, Memo, and View Change, then press ① **Apply**
4. [Fig. 6.12] Insert the sample into the pertinent cell holder and press ② **Measure** to take measurements.
5. [Fig. 6.12] If there a sample to add, insert a sample to measure into the pertinent cell holder and press ③ **Measure** to take measurements.
6. You can check the measurement data in the table.

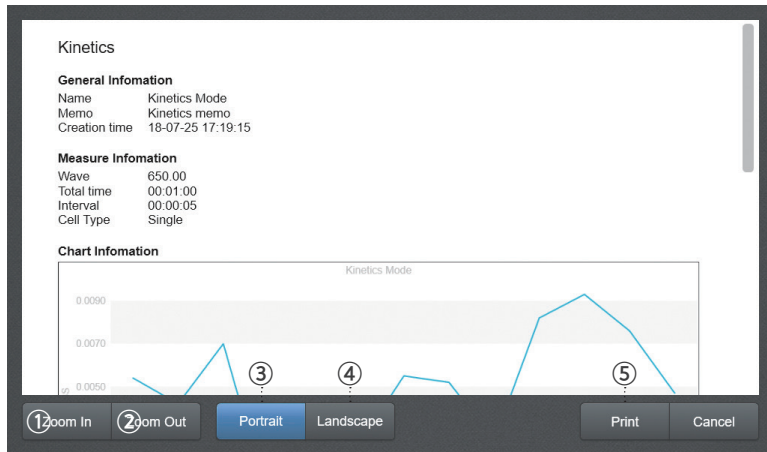

Fig. 6.13

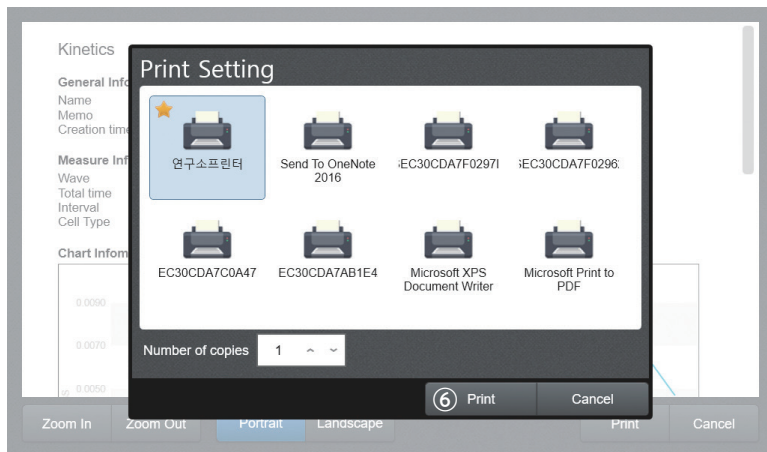

Fig. 6.14

7. Click [Fig. 6.12] **Report** to check or print the measurement data in report form.
8. [Fig. 6.13] You can zoom in or out on the printing details using the ① **Zoom In** or ② **Zoom Out** buttons.
9. [Fig. 6.13] You can check or print in landscape or portrait mode using the ③ **Portrait** and ④ **Landscape** buttons.
10. [Fig. 6.13] Check the details to print and press the ⑤ **Print** button to open the print settings screen.
11. [Fig. 6.14] Set the printer and number of pages to print on the printer settings screen.
12. [Fig. 6.14] Press the ⑥ **Print** button to start printing.

This page is intentionally left blank.

Ch. 7

Equipment Setting

- 7-1 General Setting
- 7-2 Sound Setting
- 7-3 Graph Setting
- 7-4 Table Setting
- 7-5 Network Setting
 - 7-5-1 Internal Network
 - 7-5-2 External Network
- 7-6 Device Setting
- 7-7 Account setting
- 7-8 Printer Setting
- 7-9 Information

7-1 General Setting

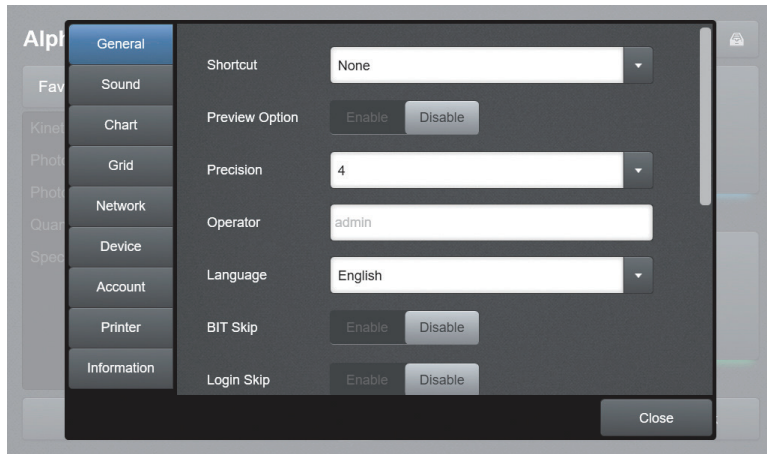

Fig. 7.1

List of Settings

Name	Description	Detailed Description
Shortcut	Selects a frequently-used mode.	The selected mode will be executed as soon as the equipment is turned on.
Preview Option	If mode is selected, the settings window will be directly displayed.	
Precision	Displays the digits of a number of the measured value.	Up to 5 digits of a number can be displayed.
Operator	Displays the login user.	
Language	Select a language to use.	
BIT Skip	Skip self-diagnosis: Skips the self-diagnosis function.	The equipment will be activated without self-diagnosis when the power is turned on, allowing measurements to be taken quickly.
Login Skip	Skips login.	The equipment will be activated without the login procedure when the power is turned on.
Update	Updates the program.	Will be displayed on the screen only when there is an update program in the external storage device.

7-2 Sound Setting



Fig. 7.2

List of Settings

Name	Description	Detailed Description
Sound	Selects whether voice support and sound effects will be used.	
Volume	Adjusts the sound volume of the equipment.	
Voice	Selects whether voice support will be used.	
Touch	Selects whether a touch sound will be used.	
Notification	Selects whether notifications will be used.	Lamp pre-heating and message notification.

7-3 Graph Setting



Fig. 7.3

List of Settings

Name	Description	Detailed Description
Title	Selects whether the graph subject will be displayed.	
Marker	Selects whether the graph marker will be displayed.	
Legend	Selects whether the graph legend will be displayed.	
Navigation	Selects whether navigation will be displayed.	The graph pan and zoom function will be displayed on the screen.
Legend Horizontal Align	Selects the horizontal location of the legend.	Left, Center, Right
Legend Vertical Align	Selects the vertical location of the legend.	Top, Middle, Bottom
색 목록	Selects a list of line colors displayed on the graph.	

7-4 Table Setting



Fig. 7.4

List of Settings

Name	Description	Detailed Description
Summary	Selects whether overview will be used.	
Fix Column	Selects whether row fixing will be used.	
Fix Row	Selects whether column fixing will be used.	Can be fixed only when the [Select column] button is displayed.
Row Selector	Selects whether the 'Select column' button will be displayed.	

7-5 Network Setting

7-5-1 Internal Network

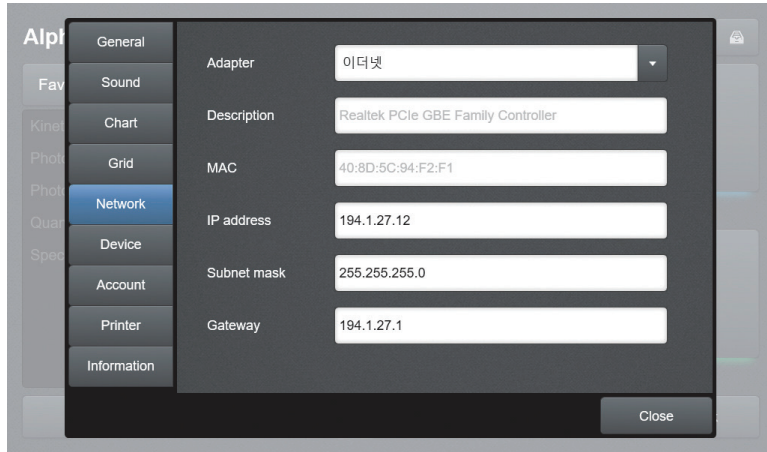

Fig. 7.5

List of Settings

Name	Description	Detailed Description
Adapter	Select a device to connect to the network.	Refers to the name of the hardware device used to connect the equipment to the network for communication.
Description	Description for adapter.	Read only
MAC	Physical address of the adapter.	Read only
IP address	Enter the network address.	
Subnet mask	Enter the subnet mask address.	
Gateway	Enter the gateway address.	

7-5-2 External Network

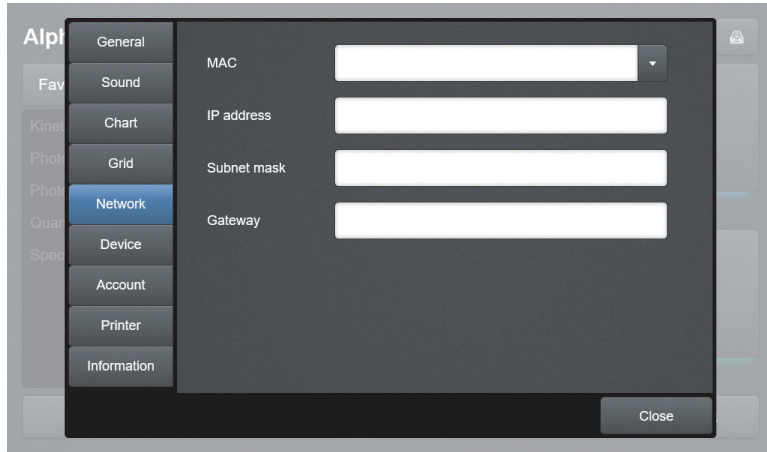

Fig. 7.6

List of Settings

Name	Description	Detailed Description
MAC	Physical address of the adapter.	Read only
IP address	Enter the network address.	
Subnet mask	Enter the subnet mask address.	
Gateway	Enter the gateway address.	

7-6 Device Setting

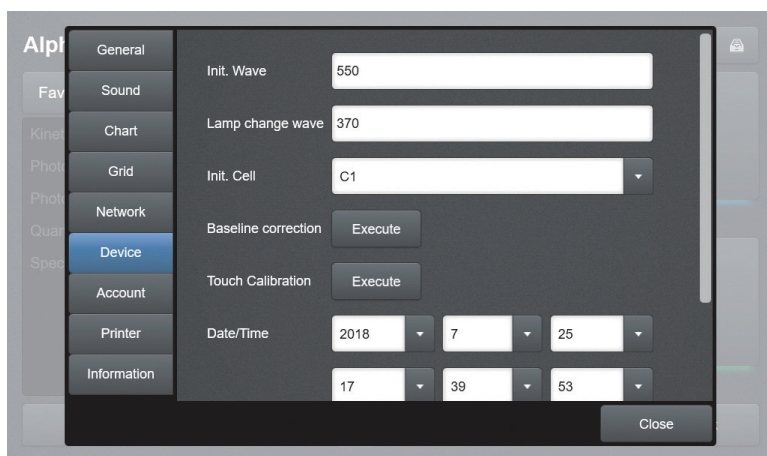

Fig. 7.7

List of Settings

Name	Description	Detailed Description
Init. Wave	Sets the initial wavelength of the equipment.	
Lamp change wave	Sets the change wavelength of the ultraviolet ray lamp and visible ray lamp.	The adjustable range is 190-1100nm.
Init. Cell	Sets the initial cell of the equipment.	
Baseline Correction	Corrects the baseline of the equipment.	
Touch Calibration	Corrects screen touch.	
Date/Time	Selects the date/time setting for the equipment.	

7-7 Account setting

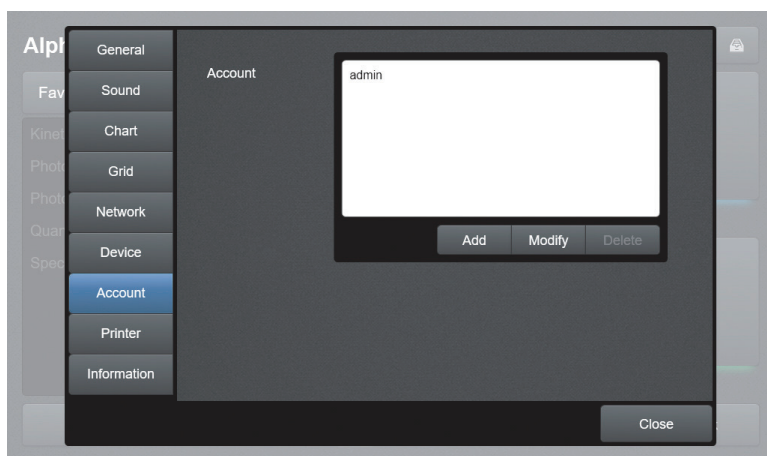

Fig. 7.8

You can manage the accounts so that only the authorized user can use the equipment. The accounts are divided into the administrator group and operation group, and available functions differ depending on the group.

Ch.7

List of Settings

Name	Description	Detailed Description
Add	Adds an account.	This menu is only available via the administrator account.
Modify	Modifies the account information.	
Delete	Deletes an account.	This menu is only available via the administrator account.

7-8 Printer Setting



Fig. 7.9

You can manage the printer connected to the network (add, change, delete, set the default printer).

Ch.7

List of Settings

Name	Description	Detailed Description
Add	Adds a printer.	
Modify	Modifies the printer name.	
Delete	Deletes the selected printer.	
Default Printer	Sets the selected printer as a default printer.	The default printer will be indicated by a yellow star.

7-9 Information

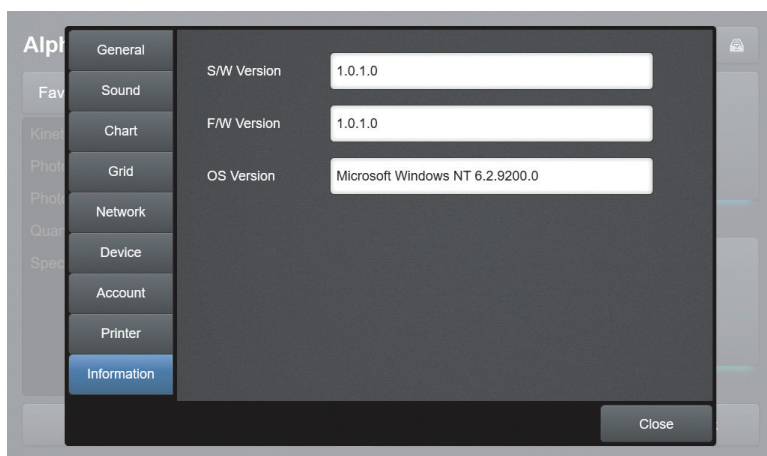

Fig. 7.10

You can check the version of software, firmware, and OS.

Information list

Name	Description	Detailed Description
S/W Version	Displays the software version of the equipment.	Users cannot change the version at their own discretion.
F/W Version	Displays the firmware version of the equipment.	
OS Version	Displays the OS version of the equipment.	

This page is intentionally left blank.

Ch. 8

Miscellaneous

8-1 Cell Type Settings

8-1-1 Single Cell

8-1-2 Multi Cell

8-2 Explorer

8-3 View Change

8-3-1 View Change (Graph)

8-3-2 View Change (Data)

8-1 Cell Type Settings

8-1-1 Single Cell

Select when using a Round Cell, Film Cell, or Long Path Cell.

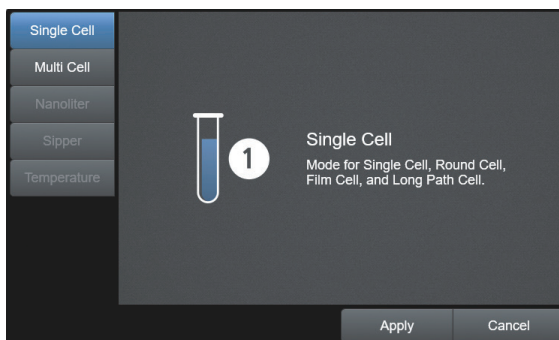

Fig. 8.1

1. Move to the [Single Cell] tab on the pertinent settings screen.
2. Cell type selection is completed when 'Apply' is pressed.

Ch.8

8-1-2 Multi Cell

General-purpose measurement mode that uses a rotation type multi-cell holder.

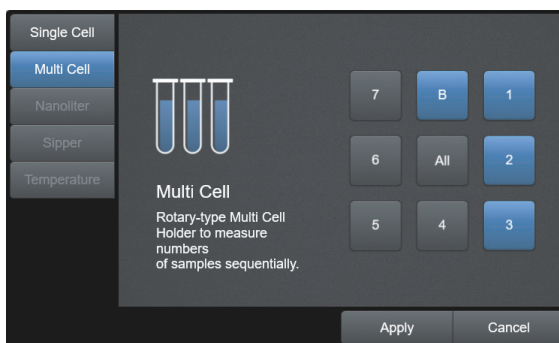

Fig. 8.2

1. Move to the [Multi Cell] tab on the pertinent settings screen.
2. To select all the 8 cells, press 'All'.
3. Cell type selection is completed when 'Apply' is pressed.

8-2 Explorer

You can copy a file between internal storage space and external storage space or delete a file, using the Explorer.

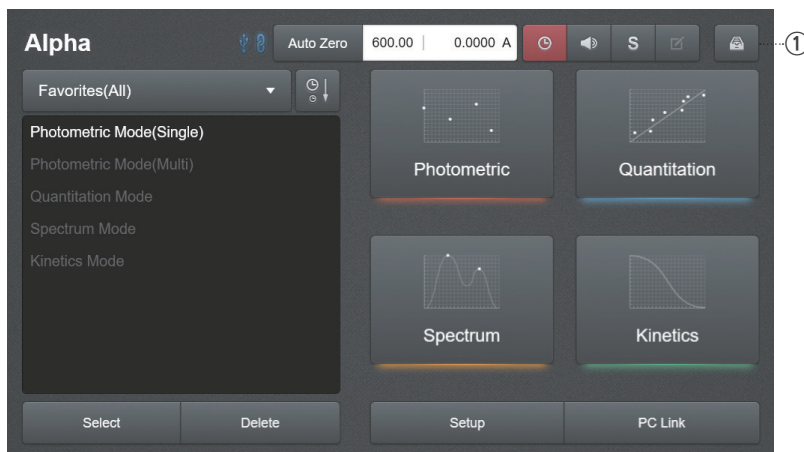

Fig. 8.3

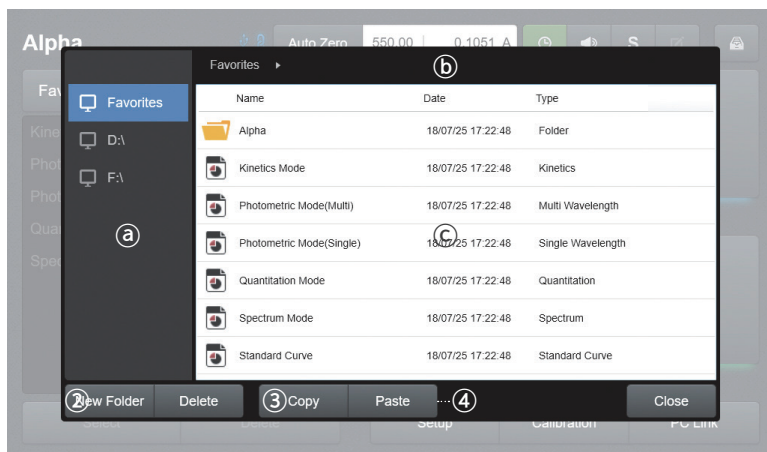

Fig. 8.4 ① Drive list / ② Data in pertaining drive / ③ Current folder location

1. [Fig. 8.3] Select the ① icon on the main screen to enter Explorer mode.
2. [Fig. 8.4] Select a drive from the ① drive list that includes a file to copy.
3. [Fig. 8.4] Select the previous folder name in ② to return to the previous folder.
4. [Fig. 8.4] Click and select a file to copy in the ③ file list.
5. [Fig. 8.4] Press ④ **Copy** to copy a file.
6. [Fig. 8.4] Select a drive and folder from the ① and ③ list. (Or press ② **New Folder** to create a new folder.)
7. [Fig. 8.4] Press ④ **Paste** to finish pasting the file.

8-3 View Change

8-3-1 View Change (Graph)

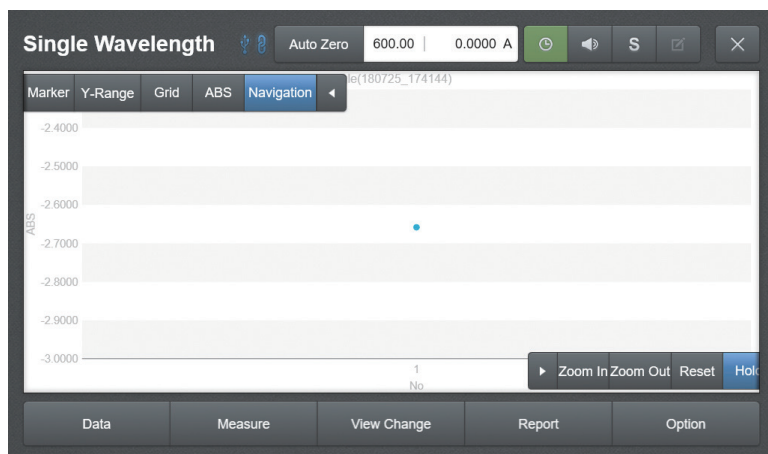

Fig. 8.5

List of Settings

Name	Description	Detailed Description
Marker	Selects whether a marker will be inserted into the measurement data.	Indicates absorbance or penetration ratio on the marker.
Y-Range	Selects the range of the Y-axis (absorbance or penetration ratio) on the graph.	
Grid	Selects whether the grid will be displayed on the graph.	
ABS/%T	Selectively displays the measurement data on the graph as absorbance or penetration ratio.	
Navigation	Displays the navigation of the graph.	

Name	Description
Zoom In	Zooms in on the graph.
Zoom Out	Zooms out on the graph.
Reset	Resets graph zoom in/out.
Hold	Changes the graph mode to Hold or Zoom.

8-3-2 View Change (Data)

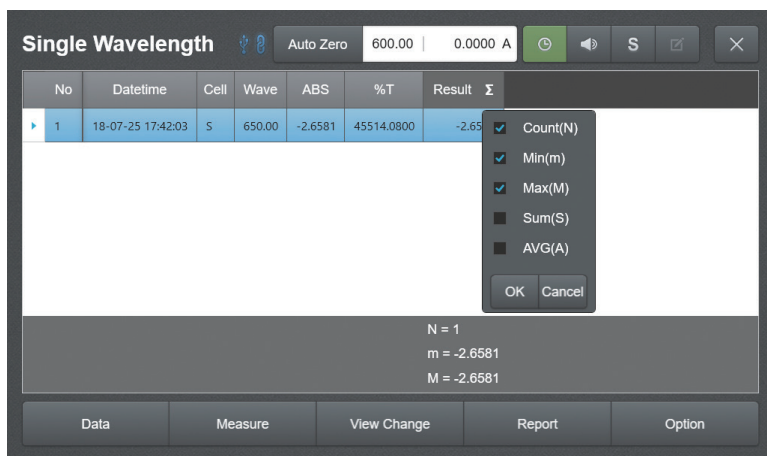

Fig. 8.6

List of Settings

Name	Description
Fix Column	Fixes the first row.
Fix Row	Fixes the selected column at the top of the table.
Summary	Selects the table overview and displays the result.

Name	Description
Count(N)	Displays the number of measured rows.
Min(m)	Displays the minimum value of the measured row data values.
Max(M)	Displays the maximum value of the measured row data values.
Sum(S)	Displays the total sum of the measured row data values.
AVG(A)	Displays the average of the measured row data values.

Ch. 9

View Basic Operation

9-1 Connection Settings

9-1-1 (Option 1) Connection setup using network (1:1 connection)

9-1-2 (Option 2) Connection setup using network (using a router)

9-1-3 Connection using a USB=Serial cable

9-2 View Operation

9-2-1 Device Connection

9-2-2 View Operation

9-1 Connection Settings

To connect the device and the View software, select the desired connection type from the table below and follow the connection procedure to perform the connection.

Connection type		External Internet Use	Reference Chapter
Connection using network	1:1 connection	Not possible	9-1-1
	Connection using a router	Possible	9-1-2
Connection using a USB-Serial Cable		Possible	9-1-3

9-1-1 (Option 1) Connection setup using network (1:1 connection)

After connecting the device and PC 1 to 1 using an ethernet cable, perform the following procedure to set up the PC.

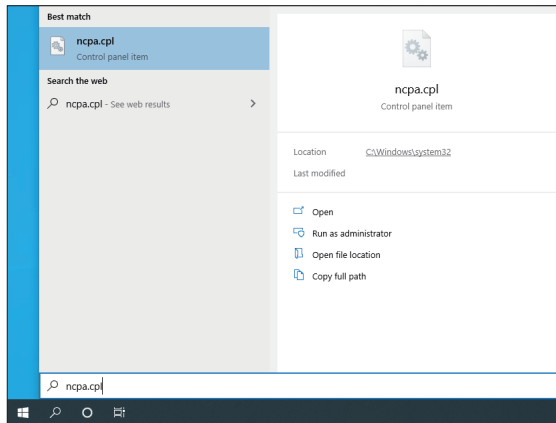

1. Enter "ncpa.cpl" in the search box at the bottom of the window and run it.

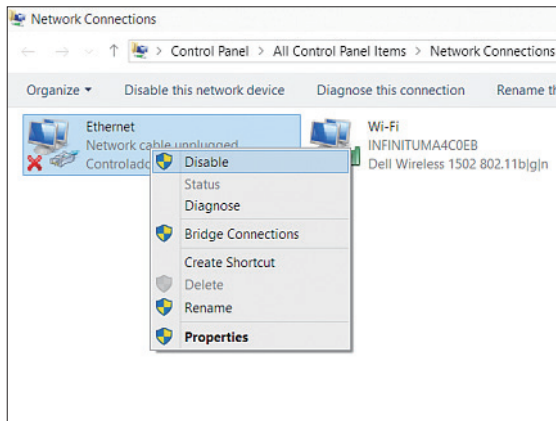

2. Right-click on the ethernet icon in the network connection window to open the properties window.

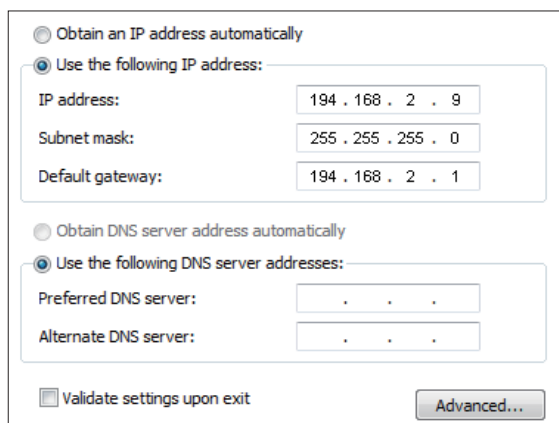
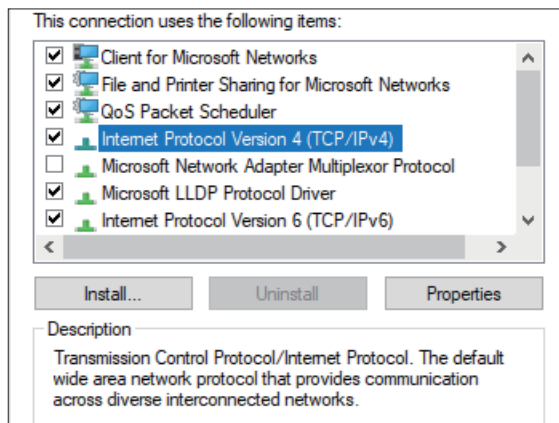

3. Select Internet Protocol Version 4 (TCP/IPv4) in the properties window and click [Properties] button.

4. Select “Use the following IP address” and enter the following, then click [OK]

IP address: 192.168.2.9

Subnet mask: 255.255.255.0

Default gateway: 192.168.2.1

To set up your device, perform the following procedure.

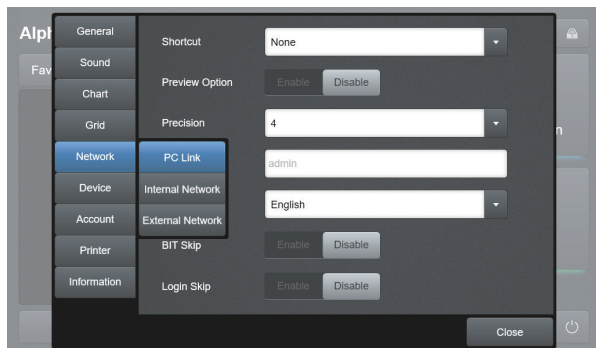

1. Click “Home screen> Setup > Network > Connection to PC” in order.

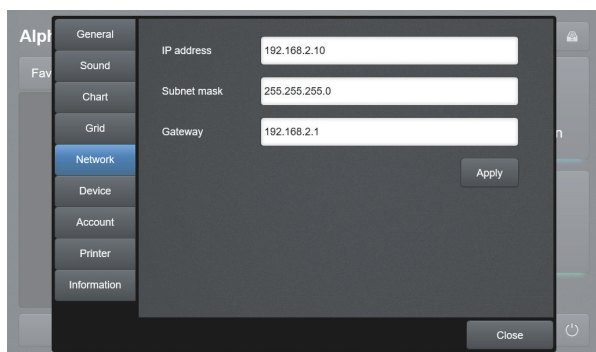

2. Enter the following and click [Apply] button.

IP address: 192.168.2.10

Subnet mask: 255.255.255.0

Gateway: 192.168.2.1

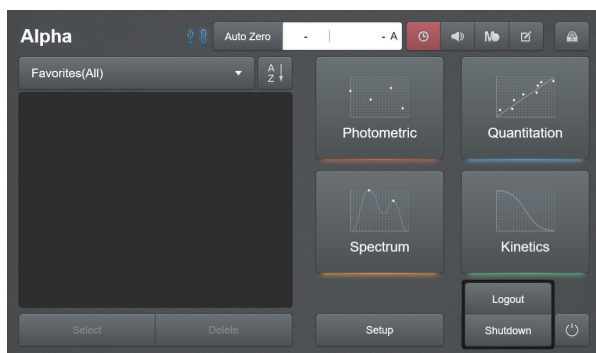

3. Shut down the device from the home screen and reboot the device.

Ch.9

(Option 2) Connection setup using network (using a router)

After connecting the router and PC, and the router and device using two ethernet cables, perform the following procedure to set up the PC.

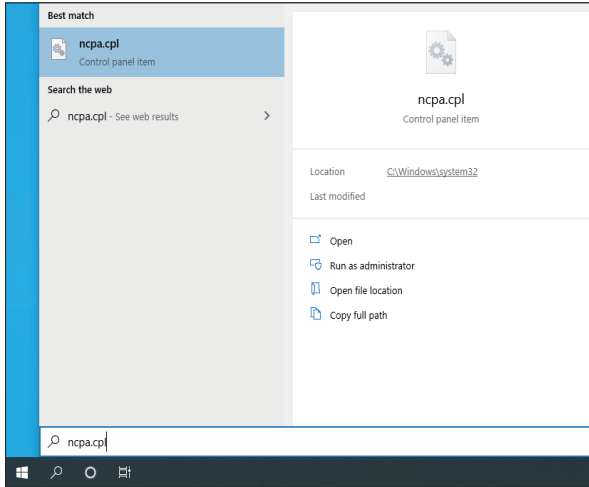

1. Enter “ncpa.cpl” in the search box at the bottom of the window and run it.

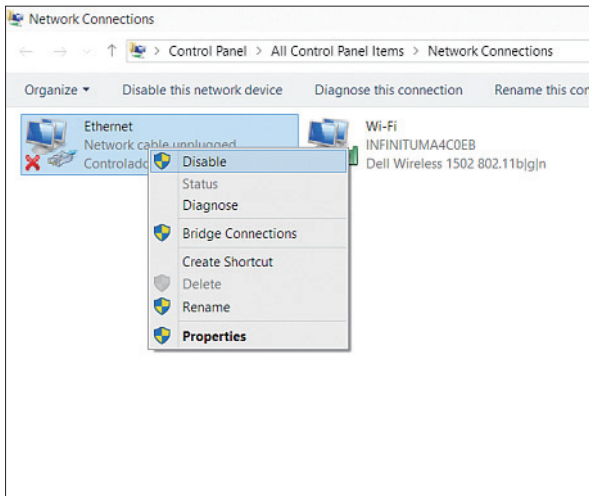

2. Right-click on the ethernet icon in the network connection window to open the properties window.

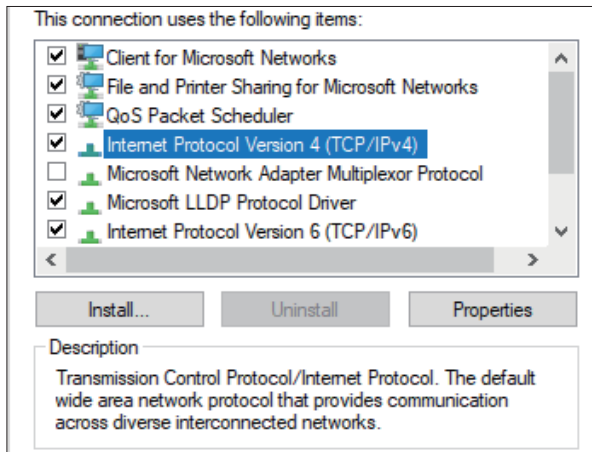

3. Select Internet Protocol Version 4 (TCP/IPv4) in the properties window and click [Properties] button.

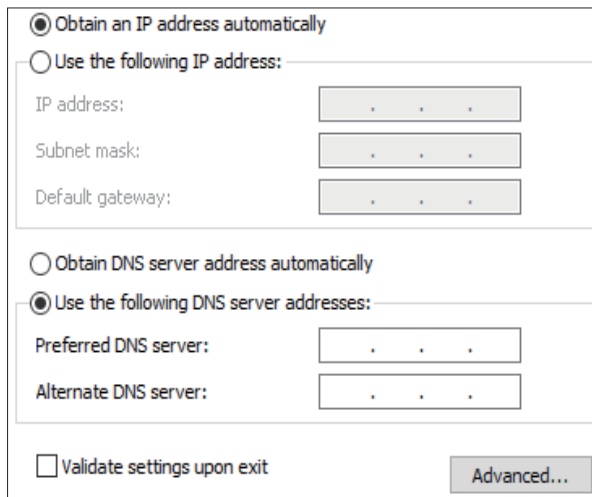

4. Select "Obtain an IP address automatically" and click [OK]

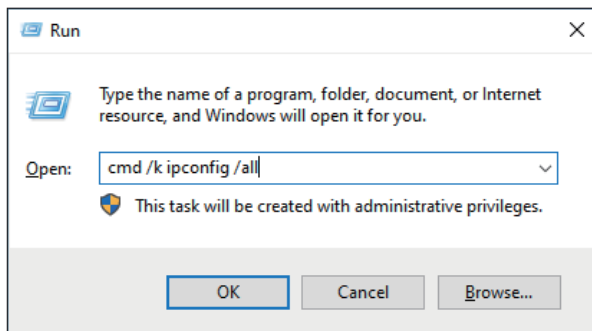

5. Enter "cmd /k ipconfig /all" in the run window and click [Enter] key.

```
Select Administrator: C:\Windows\system32\cmd.exe

Windows IP Configuration

Host Name . . . . . : DESKTOP-50U3CR2
Primary Dns Suffix . . . . . :
Node Type . . . . . : Hybrid
IP Routing Enabled. . . . . : No
WINS Proxy Enabled. . . . . : No

Ethernet adapter Ethernet:

Connection-specific DNS Suffix . . :
Description . . . . . : Intel(R) I211 Gigabit Network Connection
Physical Address. . . . . : 04-D9-F5-7F-47-6F
DHCP Enabled. . . . . : No
Autoconfiguration Enabled . . . . : Yes
Link-local IPv6 Address . . . . . : fe80::fc09:a5f3:f7a4:f4b5%9(Preferred)
IPv4 Address. . . . . : 192.168.0.212(Preferred)
Subnet Mask . . . . . : 255.255.255.0
IPv4 Address. . . . . : 194.1.27.14(Preferred)
Subnet Mask . . . . . : 255.255.255.0
Default Gateway . . . . . : 194.1.27.1
DHCPv6 IAID . . . . . : 100981237
DHCPv6 Client DUID. . . . . : 00-01-00-01-26-10-C6-25-04-D9-F5-7F-47-6F
DNS Servers . . . . . : 168.126.63.1
                        8.8.8.8
NetBIOS over Tcpip. . . . . : Enabled

Ethernet adapter Bluetooth:

2:
```

6. Check the IP address band in the prompt window. The IP band is the first three digits of your PC's IP address. e.g) 192.168.0.x

* Determine an available IP in the same band as the IP address to be used by the device. The available IP address must be the same as the PC's IP address in the first three digits, and the last digit must be different.

Note

How to find an available IP

If you cannot determine an available IP address., download "IPScanner" program and run it.

You can find an available IP address from an available IP band.

e.g.) If an available IP band is 192.168.0.x then input IP Range From 192.168.0.2 To 192.168.0.254

To set up your device, perform the following procedure.

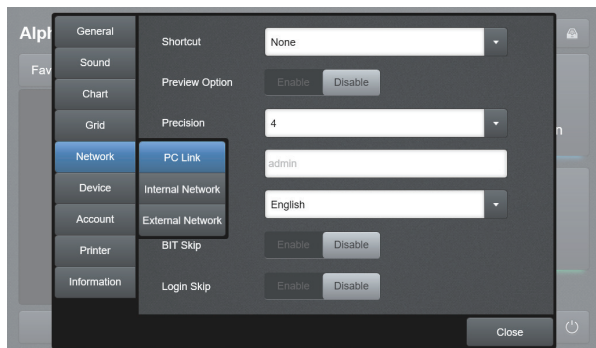

1. Click “Home screen> Setup > Network > Connection to PC” in order

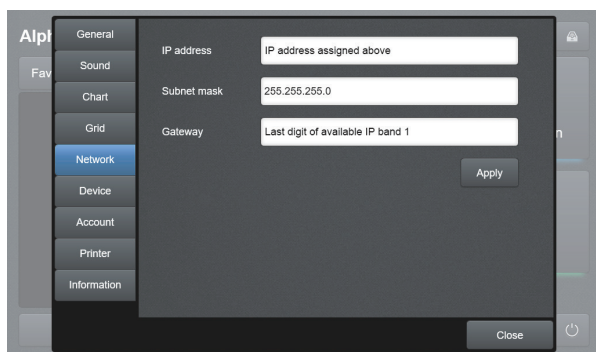

2. Enter the following and click [Apply] button.

IP address: IP address assigned above

Subnet mask: 255.255.255.0

Default gateway: Last digit of available IP band 1

e.g.) If an available IP band is 192.168.0.x
then default gateway is 192.168.2.1

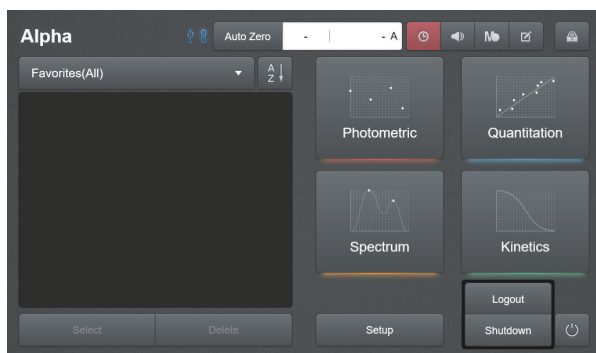

3. Shut down the device from the home screen and reboot the device.

Ch.9

9-1-3 Connection using a USB-Serial cable

After connecting the USB-Serial cable to the USB B-type port on the rear panel of the device, perform the following procedure on you PC to check the device' port.

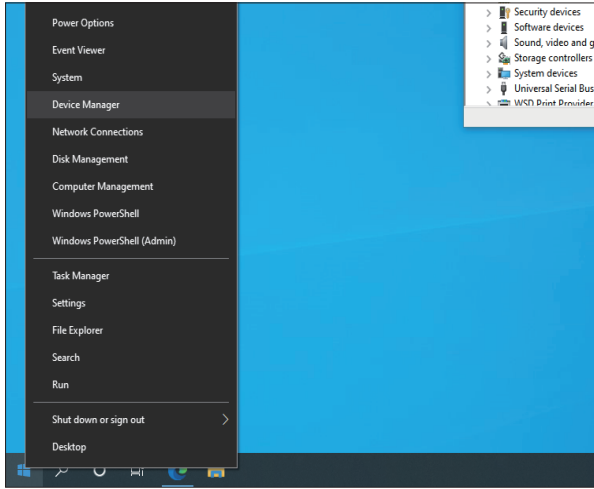

1. Enter "Device Manager" in the search box at the bottom of the window and run it.

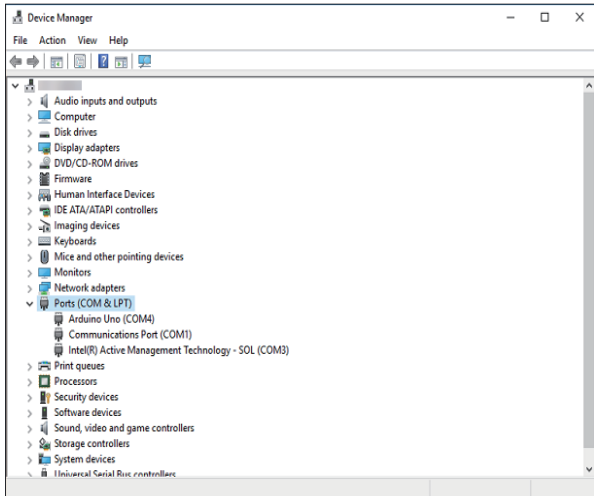

2. Check the port of the device. (Excluding COM1)

9-2 View Operation

9-2-1 Device Connection

To connect your device in the View software, perform the following procedure.

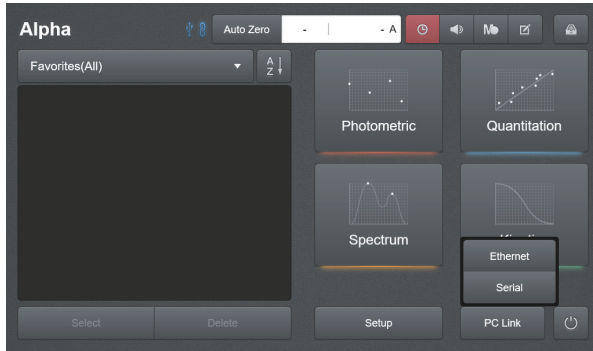

1. After checking the connection between the device and the PC, click the [Connection to PC] button at the bottom of the device home screen while the device is turned on.

Depending on the connection status, click the “Ethernet” or “Serial” and check the configuration information such as IP address or com port.

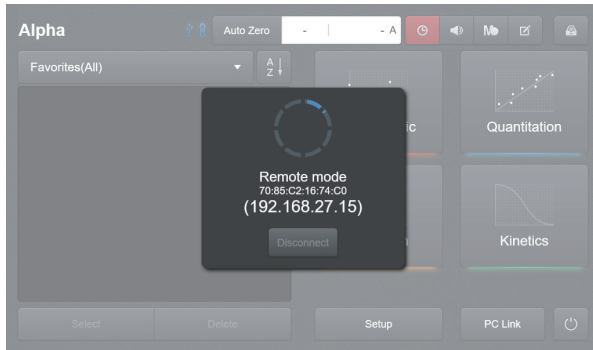

2. After running the View software, click the [Select] button on the menu.

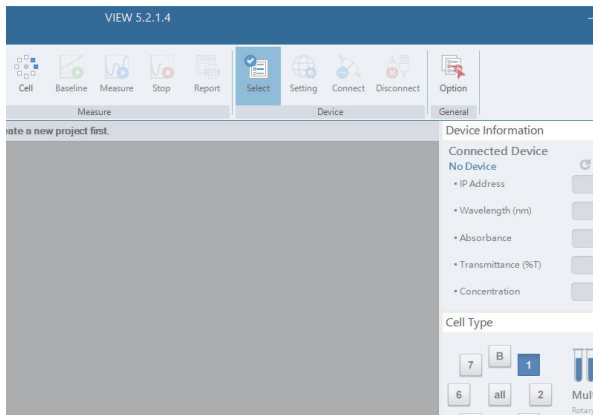



4. Select the device you want to connect and the connection type, and click the [OK]button.

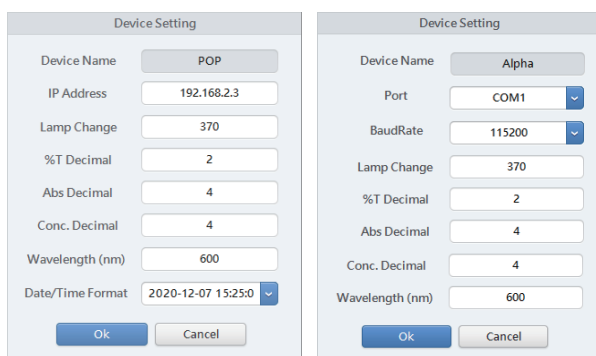

5. Enter the IP address of the device or select a port and click the [OK] button.

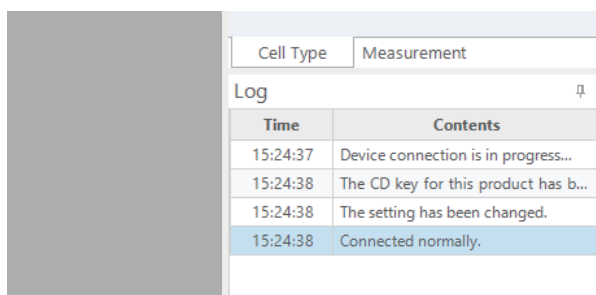

6. Check the connection status from the log message.

9-2-2 View Operation

Refer to the View User Manual.

• **Record of Revision**

Data	Revision	Changed Page	Description
06/2018	Add Contents	Add Features : Factor, Unit	

